

# INSTRUCTION MANUAL



Actual sizes shown

**MINIATURE – DECODER – From 2006**

**MX620, MX620N, MX620R, MX620F**

**MINIATURE – DECODER – Until 2005**

**MX62, MX62N, MX62R, MX62F**

**HO – DECODER**

**MX63, MX63R, MX63F, MX63T**

**HO – THIN DECODER**

**MX64, MX64R, MX64F, MX64T**

**HO – HIGH OUTPUT DECODER**

**MX64H, MX64HR, MX64HF, MX64V**

**HO – DECODER with 21-pin or PluX interface**

**MX64D, MX64DM, MX64DV, MX64P**

*MX64P planned for September 2008 (when locomotives with Plux socket exist!)*

**EDITION**

First common instruction manual for MX620 (SW version 3), MX62, MX63, MX64 (SW version 25) --- 2006 08 01  
 2006 09 20  
 2006 12 01  
 RailCom (MX63, MX64 from SW-Version 28) --- 2007 02 25  
 With loco programming examples in chapter 4 --- 2007 05 05  
 First delivery of MX64D with SW version 4, also new SW version 4 for MX620 --- 2007 08 01  
 MX62, 63, 64: SW-Version 31 / MX620, MX64D: SW-Version 6 ---- 2007 11 01  
 2008 01 20  
 MX62, 63, 64: SW-Version 32 / MX620, MX64D: SW-Version 7 ---- 2008 02 15  
 MX62, 63, 64: SW-Version 34 (new CV-Sets added) / MX620, MX64D: SW-Version 8 ---- 2008 07 03  
 MX620, MX64D: SW-Version 9 ---- 2008 07 25  
 MX620, MX64D: SW-Version 9.1 ---- 2008 10 18

0. What's new? from MX62 to MX620 or MX63, MX64 from SW version 25 .....	2
... and what's old? in the MX620, MX62, MX63 and MX64 .....	4
1. Overview .....	5
2. Technical Information .....	6
3. Addressing and Programming – CV table .....	10
4. Additional notes to Configuration Variables (CV's) .....	21
5. "Function mapping" as per NMRA Standard; and ZIMO - Extensions .....	30
6. "Bi-directional communication" .....	33
7. Installation and wiring .....	33
8. MX64D, MX64DM for C-Sinus / SoftDrive-Sinus .....	38
9. ZIMO decoders and competitor systems .....	40
10. Special - CV - Sets .....	41
11. Converting binary to decimal .....	41
12. Operating with Märklin MOTOROLA systems .....	42
13. Software Update with MXDECUP .....	43

**NOTE:**

ZIMO decoders contain an EPROM which stores software that determines its characteristics and functions. The software version can be read out from CV #7.

The current version may not yet be capable of all the functions mentioned in this manual. As with other computer programs, it is also not possible for the manufacturer to thoroughly test this software with all the numerous possible applications.

Installing new software versions later can add new functions or correct recognized errors. SW updates can be done by the end user for all ZIMO decoders since production date October 2004, see chapter 12!

Software updates are available at no charge if performed by the end user (except for the purchase of a programming module); Updates and/or upgrades performed by ZIMO are not considered a warranty repair and are at the expense of the customer. The warranty covers hardware damage exclusively, provided such damage is not caused by the user or other equipment connected to the decoder. For update service, see [www.zimo.at](http://www.zimo.at)!

## 0. What's new?

from MX62 to MX620 or MX63, MX64 from SW version 25

The MX620 family of decoders is superseding the MX62. The MX620 as well as the MX64D, MX64DV and MX64P are derived from the MX69 in terms of functions and motor control using the same powerful processor, which is an even newer design than found in the MX62, MX63 and MX64! With a few exceptions, most of the MX620 capabilities will be added to the MX62, MX63 and MX64 from SW version 25 on.

This chapter is placed ahead of the actual instruction manual to outline the essential differences of the MX620 to its predecessor. It is not meant to be a complete list of features because the MX62 was already well equipped (see chapter "and what's old").

A key feature of all ZIMO DCC decoders since September 2004, including the MX62, is the

### **User-activated software-update**

There will be a number of new features introduced to the world of DCC in the years to come (implementation and further development of bi-directional communication, extended function mapping and much more). Only if a decoder can be updated does it keep its value over time.

Updating ZIMO decoders, free of charge by the way, is done with the help of an update module MXDECUP at the track, without even opening up the engine. See last chapter in this manual.

Some of the following described features will likewise only be available with future software updates. Updates are also indispensable for fixing software bugs (that are unavoidable with software of such complexity), to take our customers' experiences and requests into consideration and to adapt the product to changing industry standards.

### **Partly automated adjustments of control parameters**

*MX620, MX64D, MX64P with first SW version; with SW version 25 for MX62, MX63 and MX64*

Optimizing the driving characteristics is now a lot simpler because the control parameters are being adjusted in part automatically. See description of CV's #9 and #56. The individual adjustment of all values like length and frequency of EMF sampling as well as proportional and integral values of the PID regulation is still possible but is in most cases no longer required.

### **Special motor control for Faulhaber- and Maxxon motors**

*MX620, MX64D, and MX64P with first SW version; with SW version 25 for MX62, MX63 and MX64*

Programming **CV #56** from **100** to **199** optimizes motor control for coreless motors; CV # 56 = 100 activates automatic fine-tuning (as described above for coreless motors). CV # 56 = 101 to 199 allows you to select the parameters manually (see description of CV's #9 and #56)!

### **Smart stop management**

*MX620, MX64D, MX64P with first SW version; with SW version 25 for MX62, MX63 and MX64*

Operational only if power is provided by an external energy source (MXSPEIG or condenser with at least 1000uF)!

If the decoder loses power while the engine is coming to a stop (dirty track, non-powered frogs etc), it ensures that the engine continues until power to the decoder is restored. Once power is restored, the engine is allowed to stop. With the engine at a standstill, the decoder again checks for track power and if necessary moves the engine a bit further.

### **"SUSI" interface with socket (MX64H), others with solder pads,**

*MX620, MX64D, and MX64P with first SW version; with SW version 25 for MX62, MX63 and MX64*

The 4 SUSI pads serve primarily for the connection of sound modules but could equally well be employed for other applications, such as: pantograph or uncoupler modules (See CV #124, Bit 7).

### **Stop on "asymmetrical DCC Signal" (Lenz „ABC“)**

*MX620, MX64D, MX64P with first SW version; with SW version 25 for MX62, MX63 and MX64; **NOT available in MX62***

This is actually a very old method developed by Umelec that allows direction dependent stop sections to be built at very little cost, with just 4 diodes.

The "asymmetrical DCC signal" offers nowhere near the functionality of ZIMO's own "signal controlled speed influence" (neither does the "ABC" method with slow-down section, sold by Lenz), but is nevertheless an alternative for simple applications; Activation with Bit 0 or 1 in CV #27.

Unreliable operation is a common problem with asymmetrical working DCC command stations (especially Intellibox) or an asymmetrical load on the track (diodes used in lighted coaches). For this reason, a special variable (CV #134) is added to the MX620 with which the necessary signal asymmetry may be changed. Practical experiences will prove whether this adjustment is actually required.

### **Km/h or mph speed regulation**

*MX620, MX64D, MX64P with first SW version; planned for MX62, MX63, MX64 if enough interest*

For some time now a desire has been expressed to control train speeds by actual km/h or mph uniform for all locos (i.e. 40 mph) instead of the usual speed step method (1-126), which represents a fraction of the loco-specific maximum speed. The MX620 offers this speed control as an alternative, activation with CV #135 = 0.

During a **calibration run**, the loco travels at medium speed for a given distance (100 scale yards). Passing the start and endpoint of this distance is registered by switching the headlights (semi-automatic procedure). CV #135 determines the conversion factor between the speed step and the actual speed. For example: if each speed step = 1km/h the speed range goes up to 126km/h; if each speed step = .5km/h the top speed is 63km/h (useful for secondary lines, trolleys, narrow gauge etc.).

This kind of control is not just for visually pleasing driving characteristics. That is the job of the BEMF load regulation. This is rather for the **exact adherence to the desired speed in mph or km/h** and/or the stopping distance. This new requirement is reached by constantly calculating, adjusting and recalculating the traveled distance. The necessary data (EMF values measured up to 200 times per second) and the computing power are available in all current ZIMO decoders.

The km/h or mph speed control offers a number of operational advantages; from the strict adherence to speed limits (caution or 35mph ...) to the trains' precise estimated time of arrival in the next station. The accuracy of this control should also bring big improvements in double or multi-traction (consisting) – although this has to be confirmed by field tests.

Activating the km/h or mph speed regulation also has one **disadvantage** though: the graduations at very low speeds are less sensitive since the speed steps from 0 to full speed are equidistant and not as denser in the low speed range, as is usually the case.

### **Distance-controlled stopping (constant stopping distance)**

*MX620, MX64D, MX64P with first SW version; with SW version 25 for MX62, MX63 and MX64*

Especially with simple automated stops (e.g. without any brake sections) like the "asymmetrical DCC signal" (Lenz ABC) or the brake generator method, a train should come to a stop in front of a red signal after a specific stopping distance (defined in CV #141), regardless of what the train's speed was before it entered the stop section. This is especially important on above simple procedures that don't use break sections

ahead of stop sections but this method may also be useful in conjunction with ZIMO's signal controlled speed influence or when stopping a train manually.

While normal deceleration (as well as acceleration) procedures are controlled by time (equal time intervals between speed steps), the deceleration time in conjunction with a predetermined stop point has to be recalculated for the remaining stopping distance.

The ZIMO implementation of "constant stopping distance" does not just include a simple adjustment of the deceleration rate based on the speed when entering a stop section. The "distance-controlled stopping" feature as implemented by ZIMO differentiates itself from other manufacturers "constant stopping distance" by the repeated recalculations of the already traveled and the remaining stopping distance with the required adaptation in deceleration rate.

 = **"bidirectional communication" as per NMRA 9.3.1 and 9.3.2**  
*MX620 from SW version 4 | MX64D, MX64P with first SW version*  
*MX62, MX63, MX64 from SW version 28 | RailCom will be further developed over the years*

All current ZIMO decoders (MX62, MX620, MX63, MX64, MX69, MX690 and MX82) are already equipped with the necessary hardware for the NMRA bi-directional communication according to RP 9.3.1 and 9.3.2. The actual data to be transmitted and its protocol will largely be decided within the scope of the NMRA-DCC-standardization and in part within the "RailCom working group" (Lenz, Kühn, Tams and ZIMO). This process started in 2006 and will continue in the years to come. Zimo will make the required software updates available accordingly.

The first release of this feature (2007) contains:

- Loco-feedback of actual speed and motor load to a global RailCom detector (internal or external of the command station),
- On-the-main read-out of CV values by the global RailCom detector,
- Loco address transmitted in broadcast mode to local RailCom detectors (in order to identify the loco address in an isolated section of track).

Note: ZIMO will first introduce in 2007/8 a global detector for the command stations MX1, MX1HS, MX1EC (also for retrofitting) and the MX31ZL (installed at the factory), for applications like speed and load display on the cab and CV-handling on-the-main, and later local detectors for track section modules. The LRC120 address display (local RailCom detector from Lenz Elektronik) can be used with the MX1EC command station beginning with the 2nd quarter of 2007; a little later with the MX1 and MX1HS as well.

RailCom is a registered trade mark of Lenz Elektronik GmbH.

### Completion of the "signal controlled speed influence"

*Planned for MX620, MX64D and MX64P; from SW version 25 on for MX62, MX63 and MX64*

The "signal controlled speed influence" (stop in front of a red signal and 5 speed limits) was implemented for ZIMO DCC systems in 1998; however, two intended characteristics were still missing. These have been (will be) added:

- Directional control: this can alternatively be used to limit the speed influence for the direction the signals are pointing (unlimited speed in opposite direction) or to prevent a train from starting up in the wrong direction after the signal turns green.
- Emergency Stop: automated stops disregarding the momentum programmed to the appropriate CV's.

### Automatic coupler detachment

*MX620 from SW version 4 | MX64D, MX64P with first version | MX62, MX63, MX64 from SW version 25*

In conjunction with the electric uncoupling (system Krois), it is possible to define the locomotive decoder so that it automatically pulls forward a specified distance away from the train while the coupler is disengaged, see CV #115.

### "Location dependent function control"

*added later with new SW versions*

Until now, this feature was only available with ZIMO function decoders; in the future it will also be available loco decoders.

With the help of the signal controlled speed influence (that is through a track section module without further expenditure), this feature will automatically operate functions such as lights, horn/whistle, bell etc.

The method described in the next section will be implemented at the same time.

### Position-Codes – Evaluation

*added later with new SW versions*

The MX9 track section module can send out position codes, also with the help of the "signal controlled speed influence", in order to inform the loco decoder of its actual position. With it, new methods of automatic train protection (collision avoidance) and layout automations can be developed particularly when used together with bidirectional communication as ZIMO intended under the designation "ARS" (also see command station and cab manuals).

### Inputs to activate functions and operating sequences or the like

*added later with new SW versions*

One of the SUSI pads can also be used as an input to actuate functions, such as an acoustic signal or to automatically trigger simple applications like shuttle train operations, automated station stops and emergency stops.

Note: Such simple operating procedures are primarily provided for the use with non-ZIMO systems. The ZIMO-DCC system provides "automated route sequences" (ARS), a much more powerful instrument for shuttle train operations and similar, stored and played back by the command station.

### LED output for Infrared-Routing

*added later with new SW versions*

With the help of an infrared-LED installed in the loco floor, the decoder can send information that can be received by a receiver-diode (sensor) installed in the track; the receiver diode is connected to an accessory decoder MX82. The kind of information that can be transmitted may be a fixed routing code (stored in a decoder CV) or a variable dependent on the functions output state. Based on the information received, the MX82 accessory decoder operates turnouts or other accessories.

With the help of Infrared-Routing, a loco can select specific routes by itself (e.g. selection of a specific siding); or the next turnout may be switched to the desired position using a loco function key on the cab, which is a typical operating feature of streetcars.

### CV-Sets – supplied or self-defined

*partly available with initial SW version, will be expanded with future SW updates*

A CV-set is stored in a decoder as a complete list of CV's with their respective values. CV-sets may be supplied with the decoder software (e.g. CV-set for electric loco with Norwegian lighting rules) but can also be defined by the user (e.g. Special acceleration and deceleration behavior for steam engines).

A so-called pseudo programming of CV #8 is employed to replace currently operational CV's with a stored CV-set (regardless whether supplied or self defined). For example: CV #8 = 47 for Norwegian lighting rules; CV #8 contains the number 145, which is the ZIMO identification code and can not really be overwritten, hence the name pseudo programming. Entering number 47 causes the decoder to load the stored CV-set containing the above lighting rules for example.

Typical applications for CV-sets are: country specific lighting rules, motor specific data for best slow speed behavior, engine specific acceleration, easy adaptation of an engine used in different trains (passenger, goods, consists) or between home layout and club operations.

### Virtual cam sensor for sound modules

*MX620, MX64D and MX64P with first SW version, MX62, MX63 and MX64 from SW-Version 25*

Function output 2 (FO2) of the MX620, if desired, serves as the cam sensor input (via SUSI for example) to a sound module (e.g. Dietz reed-switch input) and thereby saves the installation of a real cam sensor. This simulation is of course not in a position to synchronize the steam chuffs to the exact piston position but nevertheless offers a much improved wheel speed synchronization than is possible with the conventional method of speed step synchronization (see chapter 7 as well as CV #133 in the CV table).

### New function mapping procedure with CV #61 = 98

*MX620, MX64D and MX64P with first SW version, MX62, MX63, MX64 with future SW versions*

This procedure offers more flexibility in allocating function outputs (headlights and outputs F1 to F12) to function keys (F0 to F12), than is possible with fixed configuration values.

The execution of this assignment procedure however requires some extra time and a certain degree of attention from the user. ZIMO users will get support from the cab in the near future!

It can be defined which function outputs should activate with each function-direction combination (as in F0 forward, F0 reverse, F1 forward, F1 reverse etc.); multiple selections are possible. It is further possible to add the option of automated and timed turn-off (e.g. headlights), after the loco stopped and the programmed time has elapsed.

The function allocations can be combined with special effects such as US lighting, uncouplers etc. as well as CV-sets.

### Incremental CV programming

*added later with SW updates*

This will simplify the fine tuning of CV values (i.e. slow speed or acceleration and deceleration values): no need to manually enter different decimal values, which is the case with conventional CV programming, but rather increase or decrease the current value by simply pressing a function key.

### Diagnostic and statistics index

*added later with SW updates*

Operating hours, odometer readings, error reports (short circuits etc.) are continuously updated in "live" CV's and can be recalled and displayed at any time.

### Alternative data formats supported (Motorola, Selectrix, mfx)

*MX620, MX64D and MX64P with first SW version, MX62, MX63, MX64 with future SW versions*

Although DCC is far superior to Motorola or Selectrix, these two data formats are nevertheless very much in use today. It is therefore being considered to develop the required software and make it available with a future software update.

In addition to the normal MOTOROLA implementation, it will also be possible in this format to switch 8 (instead of 4) functions by linking the next higher address to the first (see CV #112, Bit 3)!

It cannot be guaranteed from today's perspective, whether the mfx format (now used by Märklin) can actually be implemented.

### Actuation of a standard or "smart" servo in a locomotive

*MX620, MX64D, MX64P from SW version 6 (Nov 2007) | not planned for other models*

Two logic outputs (alternative use of SUSI connections) are available for servo control. They can be utilized to drive pantographs, uncouplers, doors etc. The model MX64DV5 also generates the necessary 5V power. With other models, use an external voltage regulator.

### Control of C-Sinus motors (Märklin, Trix with 21-pin interface)

*MX64D with first SW version | not intended for other decoder types*

The MX64D can be switched to a special output configuration that is required for the interaction with the C-Sinus boards built into these locomotives. The decoder further supplies the 5V power the C-Sinus board needs, which ordinary decoders cannot! The MX64D is **not suitable for Softdrive-Sinus and some C-sinus drives (use MX64DM instead).**

### Control of Softdrive-Sinus motors (Märklin, Trix with 21-pin interface)

*MX64D with first SW version | not intended for other decoder types*

The MX64DM is a variant of the MX64D. The only difference is in the design of outputs FO3 and FO4 (= AUX3 and AUX4 according to NMRA interface specifications), which are built as logic level outputs that can supply the necessary 5V for powering the Softdrive loco boards. The MX64DM is **suitable for C-Sinus as well as Softdrive-Sinus.**

## ... and what's old?

in the MX620, MX62, MX63 and MX64 ...

The MX62, the predecessor to the MX620, as well as the MX63 and MX64 with earlier software versions were already equipped with many outstanding characteristics - all of them are of course still present:

High frequency motor control (up to 40kHz), adjustable load regulation, fully compatible with core less motors, exponential acceleration, US lighting effects, uncoupler control (System Krois, System Roco), NMRA-DCC function mapping, extended ZIMO function mapping, dimming, low beam, flasher, uninterrupted operation during short power interruptions, over-voltage and thermal protection, Zimo signal controlled speed influence, loco number recognition.... and much more.

# 1. Overview

The decoders described here are for the installation in N, HOe, HOm, TT, HO, OO, Om and O gauge engines. They are equally suited for locos with standard as well as core less motors (Faulhaber, Maxxon, Escap and others), for the latter the special settings in CV #56 = 100 and CV #9 = 12 are available (new in MX620 and with SW version 25 in MX62, MX63 and MX64).

ZIMO decoders operate primarily according to the **standardized NMRA-DCC data** format and can therefore be used within a ZIMO digital system as well as DCC systems of other manufacturers, the **MX620, MX64D and MX64P** can also operate with the **MOTOROLA protocol** within Märklin systems and other MOTOROLA command stations.

<b>MX620 Family</b>	<p><b>Miniature-Decoder</b> with BEMF and high frequency drive suitable for DC and coreless motors and all other ZIMO features found in larger decoders.</p> <p>ATTENTION: Extra care is required during installation because the MX620, unlike the MX63, is <u>not</u> protected by a shrink tube!</p> <p>TYPICAL APPLICATION: for the installation in N, HOe, HOm but also HO engines with limited available space or because of features that have not yet been implemented in the MX63/MX64 decoder (i.e. mph speed control).</p>
---------------------	---

**Different versions according to their connections:**

<b>MX620</b>	Version with 7 highly flexible wires (120 mm long) for track, motor and 2 functions. Solder pads are available for two additional functions and SUSI.
<b>MX620N</b>	MX620 with 6-pin interface per NEM651 and NMRA RP 9.1.1. Interface is mounted on circuit board, no wires.
<b>MX620R</b>	MX620 with 8-pin interface per NEM652 and NMRA RP 9.1.1 on 70mm wires.
<b>MX620F</b>	MX620 with 6-pin interface per NEM651 and NMRA RP 9.1.1 on 70mm wires.

<b>MX62 Family</b>	<p><b>Miniature-Decoder</b> of the previous generation (produced from 2002 to 2005). Even though this decoder is no longer being produced, it is still covered in this manual because future software updates will still be available.</p>
<b>MX63 Family</b>	<p><b>Compact loco decoder</b>, on double layer circuit board, with back-EMF, adjustable frequency from 50Hz to 40kHz (silent drive), DC and coreless motors and all other ZIMO features. Identical in functionality to the MX64 decoder!</p> <p>The decoder is well protected in a transparent shrink tube against unwanted contact with other metal parts.</p> <p>TYPICAL APPLICATION: Locomotives in HO, OO....</p>

<b>MX63 Family</b>	<p><b>Compact design</b>, double layer circuit board with back-EMF, high-frequency motor control for DC and coreless motors and all other ZIMO features. Identical in functionality to the MX64 decoder!</p> <p>The MX63 decoder is wrapped with a shrink tube and well protected against possible short circuits.</p>
--------------------	--

**Different versions according to their connections:**

<b>MX63</b>	Version with 9 highly flexible wires (120 mm long) for power, motor, 4 function outputs. Solder pads are available for further outputs (logic level) and SUSI.
<b>MX63R</b>	MX63 with 8-pin interface per NEM652 and NMRA RP 9.1.1 on 70mm wires.
<b>MX63F</b>	MX63 with 6-pin interface per NEM651 and NMRA RP 9.1.1 on 70mm wires.
<b>MX63T</b>	MX63 with 21-pin interface for locomotives from Märklin, Trix, Brawa, Liliput and others.

<b>MX64 Family</b>	<p><b>Ultra thin decoder</b> on single layer circuit board with back-EMF, adjustable frequency from 50Hz to 40kHz (silent drive), DC and coreless motors and all other ZIMO features. Identical in functionality to the MX63 decoder! The bottom of the circuit board is protected with a foil.</p> <p>TYPICAL APPLICATION: Locomotives in HO, OO...O.</p>
--------------------	--

**Different versions according to their connections:**

<b>MX64</b>	Version with 9 highly flexible wires (120 mm long) for power, motor, 4 function outputs. Solder pads are available for 4 more outputs (logic level) and SUSI.
<b>MX64R</b>	MX64 with 8-pin interface per NEM652 and NMRA RP 9.1.1 on 70mm wires.
<b>MX64F</b>	MX64 with 6-pin interface per NEM651 and NMRA RP 9.1.1 on 70mm wires.
<b>MX64T</b>	MX64 with 21-pin interface for locomotives from Trix, Brawa and others.

<b>MX64H, MX64V1, MX64V5 Families</b>	<p><b>High-output version of the MX64</b>, double sided with SUSI socket.</p> <p>MX64H - is identical in function to MX64 but with more power and 8 amplified function outputs (as compared to MX64 with 4 amplified and 4 logic outputs).</p> <p>MX64V1 - comes with additional low voltage supply of 1.5V for functions.</p> <p>MX64V5 - is the same but with 5.0V supply.</p>
---------------------------------------	--

**MX64D,  
MX64DH,  
MX64DM  
MX64DV1,  
MX64DV5  
MX64P16**

MX64D, MX64DH, MX64DM, MX64DV: with **21-pin plug**.  
MX64P: with **PluX connector (16-pin)**, according to NMRA DCC RP 9.1.1.  
All MX64 models are identical in functionality to the MX620; the model MX64DM is also suitable for locomotives with **C-Sinus** or **Softdrive-Sinus** motor (Märklin, Trix) and 21-pin socket (the MX64D is not suitable for these motors in all cases).  
MX64DV1 – is a MX64D with additional low voltage output of 1.5V  
MX64DV5 – is a MX64D with additional low voltage output of 5V (for servo control!).

## 2. Technical Information

Allowable Track voltage .....	12 - 22 V (MX64, MX64H, MX64V, MX64D and MX64P can also be operated with 24 V.)
Maximum continuous motor output.....	MX620, MX62 ..... 0.8 A MX63, MX64..... 1.2 A MX64H, MX64V..... 1.6 A MX64D, MX64DM, MX64DV, MX64P 1.2 A MX64DH (Special O gauge version) . 1,2 A
Peak motor current .....	2 A
Maximum total function output, continuous *).....	MX620, MX62 ..... 0.5 A MX63, MX64, MX64H, MX64V ..... 0.5 A MX64D, MX64M, MX64DV, MX64P .... 1 A
Maximum continuous total current (motor <b>and</b> functions).....	MX620, MX62 ..... 0.8 A MX63, MX64 ..... 1.2 A MX64H, MX64V ..... 1.8 A MX64D, MX64DM, MX64P..... 1.2 A
Operating temperature .....	- 20 to 100 °C
Dimensions (L x W x H) ... .....	MX620, MX620N excluding pins ..... 14 x 9 x 2.5 mm MX62, MX62N excluding pins ..... 14 x 9 x 3 mm MX63 ..... 20 x 12 x 4 mm MX64 ..... 26 x 16 x 3 mm MX64H, MX64V ..... 26 x 16 x 5 mm MX64D, MX64DM ..... 20.5 x 15.5 x 4.5 mm MX64DV ..... 25.5 x 15.5 x 4.5 mm MX64P ..... 20.5 x 15.5 x 4.5 mm

\*) The short circuit protection is carried out for the total current of all outputs. In the unlikely event that the outputs are turned off due to cold-start problems of light bulbs (power surge at turn-on leading to a short), the "soft-start" option should be utilized (see CV #125 = 52 etc.)!

The **special version MX64DH** is built to operate with little heat dissipation and is especially recommended for heavy O-gauge engines with 21-pin interface.

### DO-IT-YOURSELF SOFTWARE UPDATE !

Beginning with production date September 2004 (MX620 since introduction), ZIMO DCC decoders are equipped to handle a software update by the user. A **ZIMO decoder update module (e.g. MXDECUP or MXDECUPU)**, a PC with Windows operating system, a serial port (or USB and converter) and the program **ZIMO Service Tool „ZST“** is required. An Internet connection is needed to download the latest software version from ZIMO's web site [www.zimo.at](http://www.zimo.at). The update module is used independent of the command station and can therefore be used with any DCC system!

There is **no need to remove the decoder or to open up the locomotive**. Just set the locomotive on a section of track connected to the update module and start the update with the computer.

NOTE: Equipment inside the locomotive that is connected directly with the track (that is, not powered by the decoder) can interfere with the update procedure. Also energy buffers installed without heeding the advice in chapter 7 (no choke coil) may prevent a successful update.

See the **last chapter** in this manual for more information on updating decoders or [www.zimo.at](http://www.zimo.at) !

SW updates are of course still available for a small fee by sending decoders to ZIMO or your ZIMO dealer.

**OVERLOAD PROTECTION:**

The motor and function outputs of ZIMO decoders are designed with lots of reserve capacities and are additionally protected against excessive current draw and short circuits. The affected output is turned off once an overload situation exists and subsequent load tests are performed by the decoder, which is often recognized as flashing headlights

---

***Even though the decoder is well protected, do not assume it is indestructible. Please pay attention to the following:***

***Faulty decoder hook-up***, connecting the motor leads to track power for instance or an overlooked connection between the motor brushes and rail pick-ups is not always recognized by the overload protection circuit and could lead to damage of the motor end stage or even a total destruction of the decoder.

***Unfit or defective motors*** (e.g. shorted windings or commentators) are not always recognized by their high current consumption, because these are often just short current spikes. Nevertheless, they can lead to decoder damage including damage to end stages due to long-term exposure.

***The end stages of loco decoders (motor as well as function outputs) are not only at risk of high current but also voltage spikes, which are generated by motors and other inductive consumers. Depending on track voltage, such spikes can reach several hundred volts and are absorbed by special protection circuits inside the decoder. Since the capacity and speed of such circuits is limited, the track voltage should not be selected unnecessarily high; that is not higher than recommended for the rolling stock in question. The full adjustable range of a Zimo command station (up to 24V) should only be utilized in special cases. Although ZIMO decoders are suitable for 24V operation, that may not be the case when interacting with some other equipment.***

---

**THERMAL PROTECTION:**

All ZIMO decoders have the ability to measure their own operating temperature. Power to the motor will be turned off once that temperature exceeds 100°C. The headlights start flashing rapidly, at about 5 Hz, to make this state visible to the operator. Motor control will resume automatically after a drop in temperature of about 20°C, typically in 30 to 60 seconds.

**NOTE: MX64D, MX64DM APPLICATION WITH C-SINUS AND SOFTDRIVE-SINUS**

**Switch over to C- / Softdrive-Sinus before putting decoder into service (i.e. CV #112 = 7!!)**

There are different C-Sinus and Softdrive-Sinus interfaces in existence, especially where the application of FO4 is concerned (function output 4 on the 21-pin plug), which is "misused" as an ON/OFF switch for the motor in some cases. The decoder type MX64DM and some CV settings (see CV #145) take this into consideration. However, it has to be said that the pin assignment is not documented by Märklin/Trix and may vary from one model to another!

Also see chapter „MX64D, MX64DM for C-Sinus Softdrive-Sinus“!!

**MX620, MX620R, MX620F**  
**Connection side**

(= where the wires are soldered to)

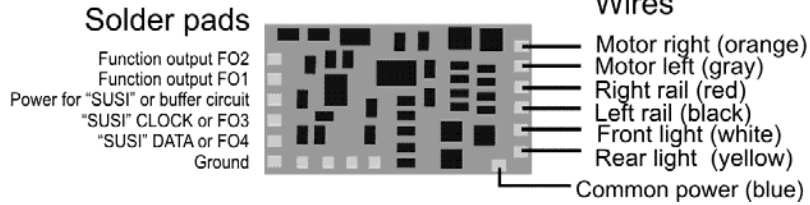

**MX620, MX620R, MX620F**  
**Controller side**

(= Wires are *not* soldered to this side !)

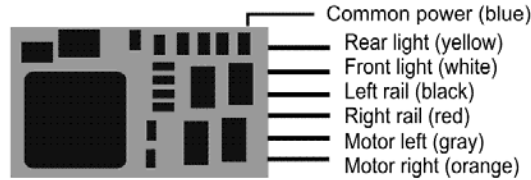

**MX620N (= MX620 with 6-pin direct interface)**  
**Controller side**

(this is the correct installation position !)

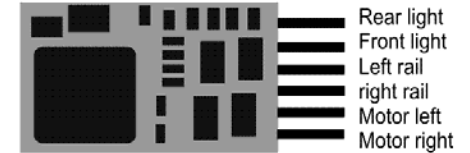

**MX63 Top View**

(Wires are connected to both sides !)

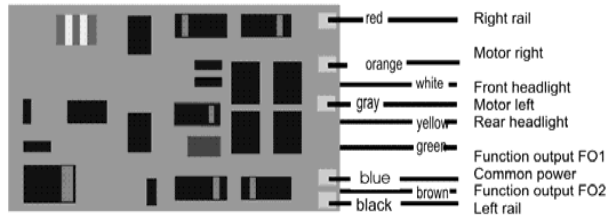

Do not touch these pads !

**MX63 Bottom View**

(= side with solder pads !)

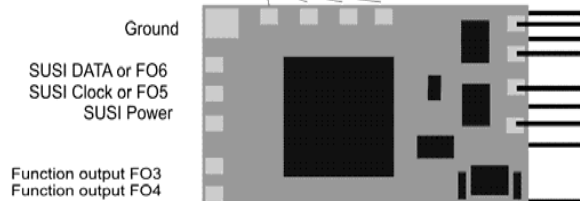

FO3, FO4, FO5 and FO6 are logic level outputs and can only be used with M4000Z !

**MX62**

**Connector side**

"Third output"

"Fourth output"

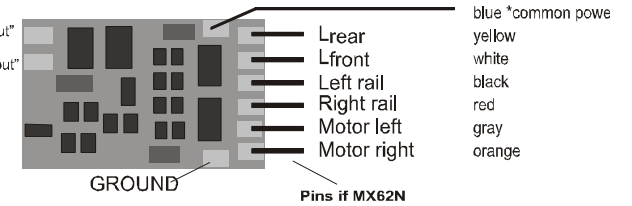

**MX64 Top view**

(= wires are soldered to this side !)

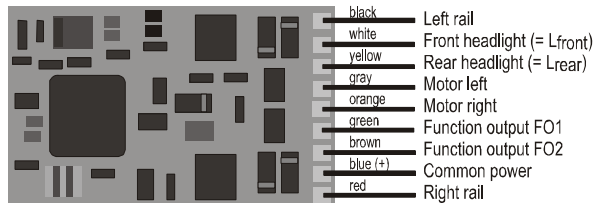

**MX64H, MX64V:**

"Normal" (amplified) outputs as solder pads on this side (bottom !)

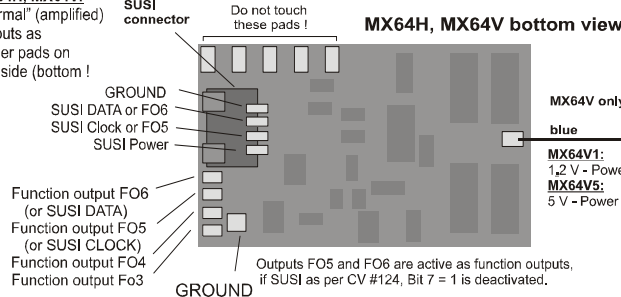

**MX64:**

These outputs are logic level outputs and can not be connected as is. Use only together with an amplifier module M4000Z or imilar on each output.

**Programming pads**

Do not touch!

**MX64 Bottom View**

(Side with solder pads!)

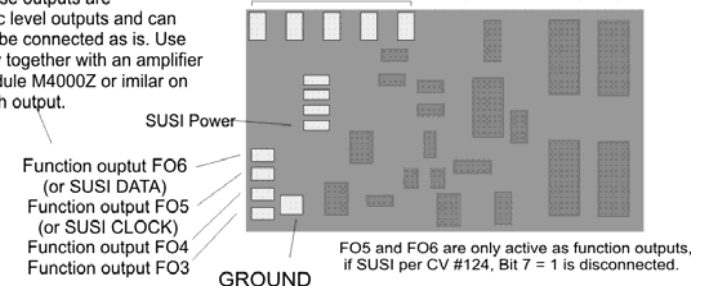

**MX64D Top View**

(= the 21-pin connector side!)

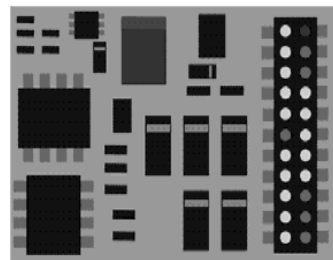

Left row

- + 5 V (20 mA max)
- Function output FO3
- Function output FO2
- Function output FO1
- Common positive
- n.c.
- Motor connection 1
- Motor connection 2
- GROUND
- Left rail
- Right rail

- Key pin
- n.c.
- n.c.
- Front headlight
- Rear headlight
- SUSI Data
- SUSI Clock
- Function output FO4
- n.c.
- n.c.
- n.c.

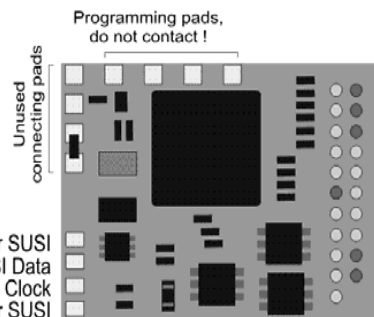

Programming pads,  
do not contact !  
Unused  
connecting pads

- GROUND for SUSI
- SUSI Data
- SUSI Clock
- Positive for SUSI

**MX64D can be installed either way:**

**MX64D plugged into loco board, i.e. TRIX**

MX64D is seen from top side, pins of loco board reach through decoder board into decoder socket.

Loco board



**MX64D plugged into loco board, i.e. BRAVA**

Plugged in MX64D is seen from the bottom side !

Loco board



**MX64DV Top View**

(= with the 21-pin connector side !)

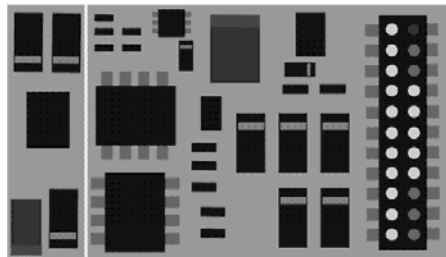

Left row

- + 5 V (20 mA max)
- Function output FO3
- Function output FO2
- Function output FO1
- Low Voltage 1,5 V**
- Low Voltage 1,5 V**
- Motor connection 1
- Motor connection 2
- GROUND
- Left rail
- Right rail

Right row

- Key pin
- n.c.
- N.c.
- Front headlight
- Rear headlight
- SUSI Data
- SUSI Clock
- Function output FO4
- n.c.
- n.c.
- n.c.

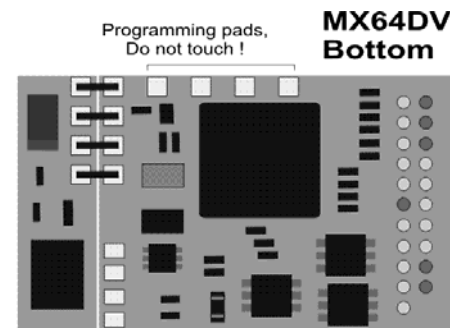

Programming pads,  
Do not touch !

**MX64DV Bottom**

**MX64DV Top**

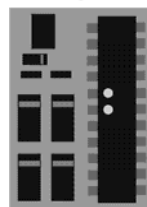

Leave jumper wires in place as delivered, if only low voltage as common power supply is needed.

- Low voltage 1,5 V
- Low voltage 1,5 V

**MX64DV Bottom**



**MX64DV Top**

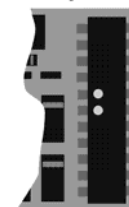

Arrange the jumper wires on the bottom side as shown, if low voltage and full track voltage is required.

- Full track voltage
- Low voltage 1,5 V

**MX64DV Bottom**

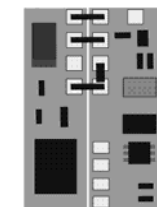

**MX64DV5 Top View**

(= the side with the 21-pin socket !)

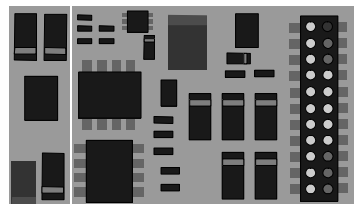

- + 5 V (20 mA max)
- Function output FO3
- Function output FO2
- Function output FO1
- Low voltage 5 V**
- Low voltage 5 V**
- Motor 1
- Motor 2
- Ground
- Left rail
- Right rail

- Lock pin
- not used
- not used
- Front headlight
- Rear headlight
- SUSI Data or Servo 2
- SUSI Clock or Servo 1
- Function output Fo4
- not used
- not used
- not used

### 3. Addressing and Programming – CV table

Every loco decoder requires a separate unique address with which the loco is controlled using a cab. **All NMRA-DCC compliant decoders have 3 as their factory default address** (NMRA standardized decoder address at delivery).

#### DECODER INSTALLATION:

After installing the new decoder in a locomotive (see chapter "Installation and wiring"), it can be tested with address #3. As a minimum, either the motor or headlights need to be connected (better yet both), to enable decoder acknowledgment during programming. Doing a complete installation before programming the decoder is often more practical.

#### THE ADDRESSING AND PROGRAMMING PROCEDURE:

The **procedure** for programming and reading of addresses and configuration variables is covered in detail in the **instruction manual for the cab (MX21, MX31....)**. For other systems consult the appropriate manual.

Programming a decoder with a PC and ADaPT software (by E.Sperrer, software developer) is a lot easier and more convenient!

---

#### Technical note to decoder acknowledgments during programming:

*When programming a decoder with a cab or computer, every successful programming step will be made visible by the decoder. The same acknowledgment method is used when reading the configuration variables.*

*The acknowledgment is based on short power pulses that the decoder generates by briefly turning the motor and headlights on, which the command station recognizes at the programming track. It follows that the acknowledgment and read out of a decoder is only successful if the current consumption is high enough, which means that the motor and headlights have to be connected or at least one of the two.*

*The decoder won't use the headlights for acknowledgment if CV #60 is set to a value of 40 or less. This is to prevent damage to bulbs since this setting is often used in conjunction with low voltage bulbs. The motor is then the only load used for acknowledgments!*

*MX64D, MX64DV, MX64P – An **alternative internal acknowledgement** can be activated:*

*These decoders have the capability to acknowledge programming steps without the normally required power consumption but instead by generating "internal high frequency short circuits"; See CV #112, Bit 1.*

---

The following pages show the tables for configuration variables (CV's).

Following the CV tables

are SUPPLEMENTAL NOTES to the application of configuration variables (CV's)

Having difficulties understanding **Bits and Bytes** when calculating single-bit CV values???

See NMRA function mapping calculator at [www.zimo.at](http://www.zimo.at), follow the links "PRODUCTS" and "Decoder" or **go to the chapter "Converting binary to decimal"** in this manual.

Within ZIMO systems:

The MX21 cab (or newer) displays Bits in a graph and decimal format. The Bits can be selected as "on" or "off" while the cab does the decimal conversion in the background!

#### HELPFUL HINTS FOR CV PROGRAMMING:

*If you are familiar with CV programming please skip this section and go directly to the CV table below!*

CV programming is not the same for all CV's. While the programming procedure is the same for all CV's, the calculation of the individual CV values varies.

For some CV's it is obvious what the value is supposed to be and can easily be derived from the "Range" and/or "Description" column in the CV table. This kind of CV acts similar to a volume control. For instance, CV#2 determines the minimum speed applied at speed step 1:

CV	Designation	Range	Default	Description
	Vstart	1 – 252 (See add. notes)	2	Entered value = internal speed step assigned to lowest cab speed step. Bit 4 in CV # 29 has to be 0; otherwise individual speed table is active.

The "range" column clearly suggests any value from 1 to 252. The higher the value the faster the engine runs at speed step 1 and vice versa.

Another similar CV is the "dimming" CV #60:

CV	Designation	Range	Default	Description
#60	Reduced function output voltage (Dimming)	0 - 255	0	The actual function output voltage can be reduced by PWM. Useful to dim headlights, for example. Example values: # 60 = 0 or 255: full voltage # 60 = 170: 2/3 of full voltage. # 60 = 204: 80% of full voltage.

Again, the range column suggests using a value between 1 and 255 and in the "description" column it is explained that the brightness of the light increases with the value.

Other CV's are easier to understand if you think of them as a small switch board, where you can turn individual switches ON or OFF. Such a CV is made up of 8 "individual switches" called Bits and the group of Bits is known as a Byte (which is the CV itself or the switch board, if you will). On some CV's you can change the setting of all 8 Bits (switches) and on others only a select few. The Bits (switches) are numbered from 0 to 7 and each has a specific value (**see the chapter "Converting binary to decimal"** for more on binary calculations). Each Bit is turned ON by adding its value to the CV and turned OFF by subtracting its value. Add the value of each Bit you want to turn ON and enter the total to the CV.

One such CV is CV #29 (next page):

CV	Designation	Range	Default	Description
#29	<p>Basic configuration</p> <p>CV #29 is calculated by adding the value of the individual bits that are to be "on":</p> <p>Values to turn "on":</p> <p>Bit 0: 1 Bit 1: 2 Bit 2: 4 Bit 3: 8 Bit 4: 16 Bit 5: 32 Bit 6: 64 Bit 7: 128</p> <p>ZIMO MX21, MX31... cabs also display the individual bits; calculating bit values is no longer necessary!</p>	0 - 63	2	<p>Bit 0 - Train direction: 0 = normal, 1 = reversed</p> <p>Bit 1 - Number of speed steps: 0 = 14, 1 = 28</p> <p>Note: 128 speed steps are always active if corresponding information is received!</p> <p>Bit 2 - DC operation (analog): *) 0 = off 1 = on</p> <p>Bit 3 - RailCom („bidirectional communication") 0 = deactivated 1 = activated see CV #28!</p> <p>Bit 4 - Individual speed table: 0 = off, CV # 2, 5, 6, are active. 1 = on, according to CV 's # 67 – 94</p> <p>Bit 5 - Decoder address: 0 = primary address as per CV #1 1 = ext. address as per CV #17+18</p> <p>Bits 6 and 7 are to remain 0!</p>

You can only change the setting of Bit 0, 1, 2, 3, 4 and 5. Bits 6 and 7 have to remain OFF because they are not yet used for anything. To calculate the total CV value you have to first look at the description field of that CV and determine which Bit (switch) you want to have ON. Let's say we want speed steps 28 active, reverse the loco's direction because it doesn't agree with the cab's direction indication and we want to use the individual speed table. This means we have to have the Bits 1, 0 and 4 turned ON (= 1). All other Bits can be OFF (= 0). In the "Designation" field it shows the value for each Bit: Bit 0 = 1, Bit 1 = 2, Bit 2 = 4, Bit 3 = 8, Bit 4 = 16, Bit 5 = 32, Bit 6 = 64, and Bit 7 = 128. If we want to have Bits 1, 0 and 4 turned ON we add up the values for these Bits (2 + 1 + 16) and enter the total of 19 to CV #29.

Lastly there is a third kind of CV that sort of fits between the other two. Here you don't have to worry about Bits and their values. With those CV's the digit's position and value determines a specific action. Some of those digit positions act like a simple ON/OFF switch and others like a volume control.

For example, CV #56 can be used for fine-tuning a motor:

CV	Designation	Range	Default	Description
#56	<p>Back-EMF control</p> <p>P and I value</p>	0 – 199 (See add. notes)	<p>0 (is equal to 55, mid-range)</p> <p><u>But:</u> default is <u>not</u> suitable for <b>coreless motors, i.e. MAXXON, FAULHABER!</b> Use "100" instead.</p>	<p>Back-EMF compensation is calculated by PID algorithm (Proportional/Integral - Differential); modifying these values may improve the compensation characteristics in certain cases.</p> <p>0 - 99: for „normal" DC motors (LGB etc) 100 - 199: for coreless (MAXXON, Faulhaber, etc...)</p> <p>Tens digit: Proportional (P) value; by default (0) is set to mid value and automatic adjustment with the goal of jerk free running. Proportional effect can be modified with settings of 1 – 4 and 6 – 10 (instead of the default 0 = 5).</p> <p>Ones digit: Integral (I) value; is set by default to a mid value. The Integral effect can be modified with settings of 1 – 9 instead of the default 0 = 5).</p>

As you can see in the "Range" field you can use any number between 0 and 199. However if you read the "Description" field it explains that each digit position controls a specific function. In this case, the hundredth digit (\_xx) sets the decoder up for a coreless motor, the tens digit (x\_x) modifies the proportional and the ones digit (xx\_) the integral action. This hundredth digit acts just like a switch. If you use the hundredth digit (1\_) the coreless motor function is turned ON. If you don't use it (\_xx), the function is turned OFF. So for a normal DC motor you would only use the ones and tenth digit. With the tens digit (0 – 9) you can modify the proportional value and with the ones digit (0 – 9) the integral value.

Don't worry about the terms "proportional" or "integral" - just use the "Step by step CV adjustment procedure" later in the manual.

**THE CONFIGURATION VARIABLES:**

Configuration Variables can be defined within the programming procedures to improve the driving characteristics of a locomotive and for many other application specific adjustments.

The meaning of Configuration Variables (CV's) is in part standardized by the NMRA DCC RECOMMENDED PRACTICES, RP-9.2.2. There are however certain CV's that are for Zimo decoders only, in some cases exclusively for specific types of Zimo decoders.

Always use the specifications for the decoder in question, since the value range may differ between manufacturers, even with standardized CV's; in this case use the table below.

CV	Designation	Range	Default	Description
#1	Primary "short" address	1 – 127	3	The "short" (1-byte) loco addresses; Is active when Bit 5 in CV #29 is 0.
#2	Vstart	1 – 252 (See add. notes)	2	Entered value = internal speed step assigned to lowest cab speed step. Bit 4 in CV # 29 has to be 0; otherwise individual speed table is active.
#3	Acceleration rate	0 - 255	1	Multiplied by 0.9 equals' acceleration time in seconds from stop to full speed.
#4	Deceleration rate	0 - 255	1	Multiplied by 0.9 equals' deceleration time in seconds from full speed to complete stop.
#5	Vhigh	0 – 252 (See add. notes)	1 (= 252)	Entered value = internal speed step assigned to highest cab speed step, according to the number of speed steps selected (14, 28 or 128). 0 and 1 = no effect. Bit 4 in CV #29 has to be 0, otherwise speed table is active.
#6	Vmid	1, A useful value for CV #6 is ¼ to ½ of the value in CV #5  (See add. notes)	1 (= about 1/3 of top speed)	Entered value = internal speed step assigned to the cabs center speed step (=step 7,14 or 63 according to the number of speed steps selected: 14, 28 or 128) "1" = default (is the same as entering a value of 85, which is 1/3 of full speed with speed regulator in center - bent speed curve). Bit 4 in CV #29 has to be 0, otherwise speed table is active.
#7	Software version  and Temporary register when programming with a "Lokmaus 2" and similar low level systems.  See section "Operation within other systems" in this manual!	Read only  all additional programming in case of Lokmaus 2 is pseudo only		This CV normally displays the decoder software version.  <b>For user of Lokmaus 2 :</b> Pseudo-programming (because programmed value is not really stored) as an initial step for programming or read-out of a higher CV (>99) and/or a higher value (>99): <b>CV # 7 = „01“ , „02“ , „10“ , „11“ , „12“ :</b> Tens digit = 1: The entered CV value will be increased by 100 during the actual programming. Tens digit = 2: ...increases by 200.  Ones digit = 1: The entered CV value will be increased by 100 during the actual programming.

CV	Designation	Range	Default	Description
				Ones digit = 2: ...increases by 200. See section „Application with ROCO Lokmaus-2“!
#8	Manufacturer ID and  HARD RESET with CV #8 = 8 or CV #8 = 0  or  LOADING of special CV sets only for MX62, MX63, MX64 and in Service Mode only.	Read only    all additional programming is pseudo only; read-out always shows "145", which is ZIMO's assigned number	145 (= ZIMO)	NMRA assigned manufacturer ID for Zimo is: 145 ("10010001") Pseudo-Programming ("Pseudo" = programmed value is not really stored): <b>CV #8 = "8" -&gt; HARD RESET</b> (NMRA standard: all CV's reset to default values). <b>CV #8 = "0" -&gt; HARD RESET</b> (ZIMO special: all CV's reset to current CV set). CV #8 = "9" -> HARD RESET for LGB-operation (14 speed steps, pulse chain). CV #8 = "... " -> Loading of supplied or user-defined CV sets; i.e. 47, 48... (also see "Special-CV-Sets").
#9	Motor frequency  and  EMF sampling rate  ATTENTION: Description for MX62, MX63, MX64 is only valid for SW version 22 or higher (earlier SW uses different definition)	0 High frequency, mid-range sampling rate  1- 99 High frequency, modified sampling rate or 255-176 Low frequency  (See add. Notes, "Step by step CV...")	0 High frequency, mid-range sampling rate  <b>Recommendation for coreless motors, i.e. MAXXON, FAULHABER:</b> <b>CV #9 = 52</b> (for HO) <b>= 22 or 21</b> (typical for O-scale)	=0 (equivalent to 55): Default motor control with high frequency (20 / 40 kHz) and an EMF-sampling rate that automatically adjusts between 200Hz (low speed) and 50Hz. Tens digit 1 - 4: Reduced sampling rate compared to default (less noise!) Tens digit 6 - 9: Increased sampling rate compared to default (to improve low speed performance!) Ones digit 1 – 4: EMF sampling time shorter than default setting (good for coreless motors for less noise, more power) Ones digit 5 - 9: EMF sampling time longer than default (may be needed for 3-pole motors or similar). MX63 and MX64 only: = 100: "Spread spectrum" – sampling rate for <b>reduced noise</b> with medium sampling time. = 255 - 176: Low frequency - PWM according to formula (131+ mantissa*4) *2exp. Bit 0-4 is "mantissa"; Bit 5-7 is "exp". Motor frequency is the reciprocal of the PWM. <u>Examples of low frequencies:</u> # 9 = 255: frequency of 30 Hz, # 9 = 208: frequency of 80 Hz, # 9 = 192: frequency of 120 Hz.
#10	EMF Feedback cut-off  NOTE: This CV is seldom required.	0 – 252  (See add. notes)	0	Assigns an internal speed step above which back EMF intensity is reduced to the level defined in CV #113. CV #10, #58 and #113 together define a back-EMF curve. If either CV #10 or #113 is set to 0 a default curve is valid.
#13	Analog functions	0 - 255	0	Selects function outputs F1 to F8 that should be "on" in analog mode. Each bit equals one function; Bit 0 = F1, Bit 1 = F2, Bit 6 = F7, Bit 7 = F8. See chapter 11 for Bit value calculation!

CV	Designation	Range	Default	Description
#14	Analog functions Acceleration and deceleration for analog operation.	0 - 127	64 (Bit 6 = 1)	Bits 5 to 0: Select function outputs F12 to F9 as well as FLr and FLf that should be "on" in analog mode. Each bit equals one function (Bit 0 = front headlight .....Bit 5 = F12). Bit 6 = 1: Analog operation without acceleration and deceleration according to CV #3 and #4. Bit 6 = 0: Analog operation with acceleration and deceleration according to CV #3 and #4. Bit 7 = 0: unregulated DC operation Bit 7 = 1: regulated DC operation
#17 + #18	Extended address	128 - 10239	0	The long 5-digit primary address (>127). This address is only active when Bit 5 in CV #29=1. Otherwise address entered in CV #1 is active (<127).
#19	Consist address	0 - 127	0	An additional address that is used to operate several locos in a consist. If a consist address is assigned to this CV, commands for the primary and extended addresses (CV's #1 and #17/18) will be ignored by the decoder. This CV is seldom used within ZIMO systems, since it is more comfortable to build and control consists with the cab (using the "normal" single addresses).
#21	Consist functions for F1 - F8	0 - 255	0	Selected functions that should operate with the consist address. (Bit 0 for F1, Bit 1 for F2, Bit 2 for F3 etc.) Applicable Bits set to 0 = function controlled by single primary address. Applicable Bits set to 1 = function controlled by consist address. See chapter 11 for Bit value calculation!
#22	Consist address active for headlights	0 - 3	0	Select whether the headlights are controlled with consist address or single address (Bit 0 for front headlight, Bit 1 for rear headlight) Respective Bit = 0: function output controlled with single address Respective Bit = 1: function output controlled with consist address See chapter 11 for Bit value calculation!
#23	Acceleration trimming NOTE: This CV is seldom required.	0 - 255	0	To temporarily adapt the acceleration rate to a new load or when used in a consist. Bit 0 - 6: entered value increases or decreases acceleration time in CV #3. Bit 7 = 0: value added. = 1: value subtracted. See chapter 11 for Bit value calculation!

CV	Designation	Range	Default	Description
#24	Deceleration trimming NOTE: This CV is seldom required.	0 - 255	0	To temporarily adapt deceleration rate to load or when used in consist. Bit 0 - 6: entered value increases or decreases deceleration time in CV #4. Bit 7 = 0: value added. = 1: value subtracted. See chapter 11 for Bit value calculation!
#27	Direction dependent stops with asymmetrical DCC signal (Lenz "ABC" method)  MX62: This feature is <b>not</b> available and it will <b>not</b> be possible to add with future SW versions.  MX63, MX64: Feature will be added with SW-Version 25. MX620: available with initial version.	0, 1, 2, 3	0	This CV activates the directional dependent stopping feature with asymmetrical DCC signal (also known as Lenz "ABC"). Bit 0 = 1: Stops are initiated if voltage in right rail is higher than left rail (in direction of travel). THIS, CV #27 = 1, IS THE COMMON APPLICATION for this feature (provided the decoder is wired to the correct rail). Bit 1 = 1: Stops are initiated if voltage in left rail is higher than right rail (in direction of travel). Stopping is directional if only one of the two bits is set (not both). Traveling in the opposite direction will have no effect. Use the other bit in case the train stops in the wrong direction! Bit 0 and 1 = 1 (value = 3): Stops in both directions. NOTE: See CV #134 for setting the asymmetrical threshold if problems are encountered (e.g. train won't stop with asymmetrical signal or stops without asymmetrical signal present). See chapter 11 for Bit value calculation!
#28	RailCom Configuration MX62, MX63, MX64: from SW-Version 28, <b>deleted with version 32!</b> MX620 from SW-Version 4, <b>deleted with version 7!</b> MX64D, MX64P with initial version	0 - 7 <b>This CV does no longer exist!</b>	3 <b>This CV does no longer exist!</b>	Use of RailCom channels (only active if RaiCom is turned on with CV #29, Bit 3): Bit 0 = 1: Channel 1 for loco address broadcast Bit 1 = 1: Channel 2 for RailCom Data Bit 2 = 1: Channel 1 for acknowledgment of received packets <b>CV #28 for RailCom has been deleted</b> with SW version 32 (MX62, MX63, MX64) and SW version 7 (MX620, MX64D)! All RailCom channels are ON if CV #29 Bit 3 = 1 (which also becomes the default setting!)

CV	Designation	Range	Default	Description
#29	Basic configuration  CV #29 is calculated by adding the value of the individual bits that are to be "on": Values to turn Bit "on": Bit 0: 1 Bit 1: 2 Bit 2: 4 Bit 3: 8 Bit 4: 16 Bit 5: 32 Bit 6: 64 Bit 7: 128  ZIMO MX21, MX31... cabs also display the individual bits; calculating bit values is no longer necessary!	0 - 63	14	<p>Bit 0 - Train direction: 0 = normal, 1 = reversed</p> <p>Bit 1 - Number of speed steps: 0 = 14, 1 = 28</p> <p>Note: 128 speed steps are always active if corresponding information is received!</p> <p>Bit 2 - DC operation (analog): *) 0 = off 1 = on</p> <p>Bit 3 - RailCom („bidirectional communication") 0 = deactivated 1 = activated = Default from SW-Version 32 (MX62, MX63, MX64) or 7 (MX620, MX64D)</p> <p>Bit 4 - Individual speed table: 0 = off, CV # 2, 5, 6, are active. 1 = on, according to CV 's # 67 – 94</p> <p>Bit 5 - Decoder address: 0 = primary address as per CV #1 1 = ext. address as per CV #17+18</p> <p>Bits 6 and 7 are to remain 0!</p> <p><u>Example:</u> #29 = 2: normal direction, 28 speed steps, DCC operation only, speed table according to CV #2, 5, 6, primary address as in CV #1. #29 = 14: DC mode and RailCom added. #29 = 22: DC mode and individual speed table according to CVs #67 – 94 added. #29 = 0: 14 (instead of 28) speed steps, necessary for some older third party systems.</p> <p>*) For polarity dependent <b>DC braking</b>, set CV #29, Bit 2 = "0" and CV 124, Bit 5 = "1"! *) For polarity independent DC braking (<b>Märklin brake-modules</b>) set CV #29, Bit 2 = "0" and CV 124, Bit 5 = "1" and additionally CV #112, Bit 6 = 1!</p>
#33 #34 #35 #36 #37 #38 #39 #40 #41 #42 #43 #44 #45 #46	Function mapping	(See add. notes)	1 2 4 8 2 4 8 16 4 8 16 32 64 128	<p>Function mapping according to NMRA: #33 - 46 = 1, 2, 4... Outputs are set to F0 - F12 by default. Headlight switches with direction and can be turned on/off with F0 key (Key #1 or L on Zimo cab).</p> <p>Special case MX620: Since the decoder only has 6 function outputs, the registers from #37 up are moved to the empty Bits on the right, which allows these outputs to be moved to higher function keys.</p> <p>Also see NMRA function mapping and MX620 mapping table at the end of this chapter.</p>
#49	Signal controlled acceleration ZIMO „HLU" - Method	0 - 255	0	<p>Entered value multiplied by .4 equals acceleration time in seconds from stop to full speed when: "ZIMO signal controlled speed influence" (requires ZIMO MX9 track section module or (TSE) track</p>

CV	Designation	Range	Default	Description
				<p>section encoder) or "asymmetrical DCC signal" method (Lenz ABC) is employed.</p>
#50	Signal controlled deceleration ZIMO „HLU" - Method	0 - 255	0	<p>Entered value multiplied by .4 equals acceleration time in seconds from full speed to complete stop when: "ZIMO signal controlled speed influence" (requires ZIMO MX9 track section module or (TSE) track section encoder) or "asymmetrical DCC signal" method (Lenz ABC) is employed.</p>
#51 #52 #53 #54 #55	Signal dependent speed limits #52 for "U", #54 for "L", #51, 53, 55 for intermediate steps	0 - 252	20 40 (U) 70 110 (L) 180	<p>Each of the 5 speed limits (CV's #51 – 55) that can be applied with the ZIMO "signal controlled speed influence" can be defined with an internal speed step. These CV's are also intended for use with the "asymmetrical DCC signal stop" in case it'll be further developed for more speed limits. ZIMO „HLU": also see CV's #137, 138, 139 !</p>
#56	Back-EMF control P and I value  ATTENTION: Description for MX62, MX63, MX64 is only valid for SW version 22 or higher (earlier SW uses different definition)	0 - 199 (See add. notes)	0 (= to 55, mid-range) <b>Recommended for coreless motors, i.e. MAXXON, FAULHABER: CV #56 = 100</b> (possibly as starting point for fine-tuning)	<p>Back-EMF compensation is calculated by PID algorithm (Proportional/Integral - Differential); modifying these values may improve the compensation characteristics in certain cases. 0 - 99: for „normal" DC motors 100 - 199: for coreless (MAXXON, Faulhaber, etc.) Tens digit: Proportional (P) value; by default (0) is set to mid value and automatic adjustment with the goal of jerk free running. Proportional effect can be modified with settings of 1 – 4 and 6 – 10 (instead of the default 0 = 5). Ones digit: Integral (I) value; is set by default to a mid value. The Integral effect can be modified with settings of 1 – 9 instead of the default 0 = 5).</p>
#57	Voltage reference	0 – 255 (See add. notes)	0	<p>The entered value divided by ten is the peak voltage applied to the motor at full speed. #57 = 0: results in automatic adjustment to current track voltage (relative reference).</p>
#58	Back-EMF intensity	0 – 255 (See add. notes)	255	<p>Intensity of back-EMF control for lowest speed step. Example: # 58 = 0: no back-EMF # 58 = 150: medium compensation, # 58 = 255: maximum Compensation. If required, an "intensity curve" can be achieved using CV #10, 58 and 113 to reduce load regulation at higher speeds.</p>

CV	Designation	Range	Default	Description
#59	Signal dependent reaction time	0 - 255	From SW version 13: 5 (older versions default value: 0)	This value divided by 10 is the time in seconds it takes to start a signal controlled acceleration after receiving a higher speed limit command with: "ZIMO signal controlled speed influence" (requires ZIMO MX9 track section module or (TSE) track section encoder) or "asymmetrical DCC signal" method (Lenz ABC).
#60	Reduced function output voltage (Dimming)	0 - 255	0	The actual function output voltage can be reduced by PWM. Useful to dim headlights, for example. Example values: # 60 = 0 or 255: full voltage # 60 = 170: 2/3 of full voltage. # 60 = 204: 80% of full voltage.
#61	Special ZIMO function mapping	MX62 - 64: 1 to 6 MX620 MX64D, MX64P: 98, 99 (See function mapping)	0	For applications not covered by NMRA function mapping (CV #33 - #46), for example: "Swiss lighting"; see "function mapping – ZIMO extensions". MX62, MX63, MX64: = 3, 4.... Special function mapping table for often used lighting variations. = 97: In contrast to the normal NMRA mapping is the shift to the left dropped for CV #37 and up. MX620: = 98: starts a flexible function mapping for directional function control, automated function turn-off after stopping and more. See chapter 11 for Bit value calculation!
#65	Subversion number <b>MX620, MX64D only!</b>	Read only CV!		This CV indicates the subversion number of a version noted in CV #7 (i.e. Version 4.2: CV #7 = 4 and CV #65 = 2). 0 - 99: Normal subversions 100 - 199: Beta-Versions 200 - 255: Special versions (usually custom versions)
#67-94	Individual speed table	0 – 252 (See add. notes)	**)	User programmable speed table. Only active if Bit 4 in CV #29 is set to 1. Each CV corresponds to one internal speed step that can be "mapped" to an external step (in-between speed steps will be interpolated when using 128 speed steps).
#66 #95	Directional speed trimming	0 - 255 0 - 255	0 0	Multiplication of the current speed by "n/128" (n is the trim value in this CV) #66: for forward direction #95: for reverse direction
#105 #106	User data	0 – 255 0 – 255	0 0	Free memory space to store user supplied data.
#112	Special ZIMO configuration bits	0 – 255 Bits 0,1 (C-Sinus)	4 =	Bit 0 = 0: Normal application = 1: For C-Sinus (Softdrive) Motor application; also see CV #145. Bit 1 = 0: Normal „service mode“

CV	Designation	Range	Default	Description
	Values to turn Bit "on": Bit 0: 1 Bit 1: 2 Bit 2: 4 Bit 3: 8 Bit 4: 16 Bit 5: 32 Bit 6: 64 Bit 7: 128	<b>only for MX64D</b> Bit 4 from SW-Version 25 for MX62, MX63, MX64!	00000100	acknowledgement = 1: Special acknowledgement with "internal high frequency shorts", for C-Sinus. Bit 2 = 0: Loco number recognition off = 1: ZIMO loco number recognition on (Turning the loco number recognition off prevents a possible ticking sound if this feature is not used). Bit 3 = 0: reacts only to the (new) NMRA-MAN-Bit, <b>12 function mode</b> = 1: reacts to old MAN bit also, <b>8 function mode</b> Bit 4 = 0: Pulse chain recognition off = 1: Pulse chain recognition on (use with LGB systems) Bit 5 = 0: 20 kHz frequency = 1: 40 kHz frequency Bit 6 = 0: normal (also see CV #129 description) = 1: non-directional DC braking („Märklin-Brake mode) Bit 7 = 0: no pulse chain generation = 1: Generates pulse chain commands for LGB sound modules on output FO1. Only in MOTOROLA format: Bit 3 = 0: normal, 4 functions for each address = 1: next higher address is used to control 4 more functions, for a total of 8 functions, which is otherwise not possible within a MOTOROLA system.
#113	EMF reduction Note: This CV is rarely necessary	0 – 255 (See add. notes)	0	Intensity of back-EMF is reduced above the speed step defined in CV #10, to the value entered here. Together, CV #10, #58 and #113 define a BEMF curve. If set to 0, BEMF is totally cut-off above the speed step defined in CV #10.
#114	Dimming mask	Bits 0 - 5	0	Bit 0 to 5 for one function output each (Bit 0 = front headlight, Bit 1 = rear headlight, Bit 2 = function output F1, etc.) Bit value=0: Output dimmed to value defined in CV #60. Bit value=1: Output not dimmed. See chapter 11 for Bit value calculation!
#115	Uncoupler control (KROIS and ROCO) "Pull-in" time and "hold" voltage CV # 115 alternatively used for additional dim value (0-90% according to ones digit, set tens digit	0 – 99 See add. notes	0	Active if "uncoupling" is selected (with value of 48) in CV #125.....132: Tens digit = 0 - 9, pull-in time in seconds of applied full voltage: Value: 0 1 2 3 4 5 6 7 8 9 Seconds: 0 .1 .2 .4 .8 1 2 3 4 5 Ones digit = 0 to 9, hold power in percent of track voltage, 0 - 90%. Applied after the pull-in time elapsed (ROCO uncoupler)

CV	Designation	Range	Default	Description
	to 0)			
#116	Automated uncoupling procedure MX62, MX63, MX64: from SW-Version 25 MX620: SW-Vers. 3	0 – 99 100 – 199 See description in chapter 7!	0	Tens digit (0 – 9): Length of time the loco should move away from train; values as in CV #115. Ones digit (0 – 9) x 4 = Internal speed step applied to loco (Momentum per CV #3 etc.) Hundredths digit = 0: No tension relieve. = 1: Tension relieve: loco moves toward coupler (to relieve tension) before moving away.
#117	Flasher	0 – 99	0	Duty cycle for flasher function: Tens digit = on time (0 = 100msec.....9 = 1 sec) Ones digit = off time (0 = 100msec.....9 = 1 sec)
#118	Flashing mask	Bits 0 – 7	0	Bit 0 to 5 for one function output each (Bit 0 = front headlight, Bit 1 = rear headlight, Bit 2 = function output F1, etc.) Bit values = 0: no flasher Bit values = 1: output flashing Bit 6 = 1: 4th output flashing inverse! Bit 7 = 1: 6th output flashing inverse! See chapter 11 for Bit value calculation!
#119	Low beam mask for F6	Bits 0 - 7	0	Bit 0 to 5 for one function output each (Bit 0 = front headlight, Bit 1 = rear headlight, Bit 2 = function output F1, etc.) Bit values = 0: no low beam function Bit values = 1: Low beam with key F6, brightness determined by value in CV #60. Bit 7 = 0: normal effect of F6. = 1: effect of F6 inverted. See chapter 11 for Bit value calculation!
#120	Low beam mask for F7	Bits 0 - 7		Same as in CV #119 but for F7 key.
#121	Exponential acceleration	0 – 99 (See add. notes)	00	Acceleration time (momentum) can be stretched in the lower speed range: Tens digit: Percentage of speed range to be included (0 to 90). Ones digit: Exponential curve (0 to 9).
#122	Exponential deceleration	0 – 99 (See add. notes)	00	Deceleration time (momentum) can be stretched in the lower speed range: Tens digit: Percentage of speed range to be included (0 to 90). Ones digit: Exponential curve (0 to 9).

CV	Designation	Range	Default	Description
#123	Adaptive acceleration and deceleration	0 – 99 (See add. notes)	0	Raising or lowering the speed to the next internal step occurs only if the preceding step is nearly reached. The tolerance for reaching the preceding step can be defined by this CV (the smaller this value the smoother the acceleration/deceleration). Tens digit: 0 - 9 for acceleration Ones digit: 0 - 9 for deceleration Value 0 = no adaptive accel. or decel.
#124	Shunting key functions:  Momentum reduction or deactivation  and  Low gear  and  SUSI assignment.	(See add. notes)	0	Bit 2 = 0: "MAN" key for shunting, = 1: F4 key for shunting (see Bit 6 for F3 key instead of F4) Bit 0 = 0: no effect with above key's = 1: removes momentum of CV #121+122 Bit 1 = 0: no effect, = 1: CV #3 + 4 reduced to ¼. Bit 0 + Bit 1 = 0: no effect = 1: removes all momentum above. Bit 3 = 1: F7 as half speed key Bit 4 = 1: F3 as half speed key Bit 5 = 1: For "DC" stopping method *) Bit 6 = 1: F3 as shunting key (instead of F4 as in Bit 2). Bit 7 = 0: SUSI activated. = 1: SUSI deactivated. Solder pads can be used instead as logic outputs on FO3 and FO4 (MX620) or logic outputs on FO5 and FO6 (MX63, MX64). *) If polarity dependent "DC" stopping method is used (i.e. Märklin), set CV #29, Bit 2 = 0 and CV #124, Bit 5 = 1! See chapter 11 for Bit value calculation!
#125 <sup>1</sup>	<b>Special effects</b> Uncoupler, "soft start" of function outputs at activation or American lighting effects for front headlights.  Operates with F0 in forward direction by default, unless assigned different	Effects 56 and up are <u>only available</u> in MX620 and MX64D decoders from SW version 7 on.  <u>Not available</u> in MX62, MX63 or MX64.	0	The CV definitions described here are valid for CV #125 to #132. Some of the functions below may not necessarily be suitable for CV #125 and #126 as these outputs are usually connected to headlights.  Bits 0,1 value = 0: independent of direction =1: active in forward direction =2: active in reverse direction ATTENTION: change CV's #33, 34.... if direction is wrong! Bits 2 - 7 value = 4 Mars light = 8 Random Flicker = 12 Flashing headlight

<sup>1</sup> Note to ditch lights: Ditch lights are only active when headlights and function F2 (#3 on Zimo cab) are on, which is prototypical for North American railroads. The ditch lights will only be working if the applicable bits in CV #33 and 34 are on (the definition in CV #125 - 128 in itself is not enough but a necessary addition).  
Example: If ditch lights are defined for F1 and F2, the bits #2 and 3 in CV #33 and 34 have to be set accordingly (i.e. CV # 33 = 13 (00001101), CV #34 = 14 (00001110)).

CV	Designation	Range	Default	Description
	through function mapping. Effects can be further adjusted and modified with CVs #62 - 64 and CV #115 (for uncoupler).			= 16 Single pulse strobe = 20 Double pulse strobe = 24 Rotary beacon simulation. = 28 Gyalrite = 32 Ditch light type 1, right = 36 Ditch light type 1, left = 40 Ditch light type 2, right = 44 Ditch light type 2, left = 48 Uncoupler as in CV#115 = 52 Soft start up of function output = 56 Automatic stop lights for street cars, see CV #63 = 60 Function output turns off automatically at speed >0 (i.e. turns off cab light at start). = 64 Function output turns off automatically after 5 min. (i.e. to protect a smoke generator from overheating). = 68 Autom. Turns off after 10 minutes.  <u>EXAMPLES</u> You want : Program CV #125 to: Mars light forward only - 5 Gyalrite independent of direction - 28 Ditch type 1 left, only forward - 37 <b>Uncoupler- 48</b> <b>Soft start of output- (i.e. headlights) 52</b> <b>Automatic stop light 56</b>
#126	<b>Special effects</b> For rear headlight (default F0 reverse)		0	Bits 0,1 value = 0: independent of direction =1: active in forward direction =2: active in reverse direction ATTENTION: change CV's #33, 34.... if direction is wrong! See CV #125 for details.
#127	<b>Special effects</b> for FO1 (default F1)		0	See CV #125 for details. The "ATTENTION" note in CV #125 and #126 are <u>not</u> relevant for this and the following CV's (#127...); they are usually not assigned to direction dependent functions!
#128	<b>Special effects</b> For FO2 (default F2)		0	See CV #125 for details.
#129 - #130	<b>Special effects</b> For FO3, FO4 (default F3, F4)	MX62, MX63, MX64: from SW-Version 22 and up	0	See CV #125 for details. MX620: Only usable if outputs FO3 and FO4 are activated by deactivating the SUSI function (CV #124, Bit 7 = 1).
#131 - #132	<b>Special effects</b> for FO5, FO6 (default F5, F6)	MX63, MX64: from SW-Version 22 and up	0	See CV #125 for details. MX63, MX64 and MX64H: Only usable if outputs FO5 and FO6 are activated by deactivating the SUSI function (CV #124, Bit 7 = 1).

CV	Designation	Range	Default	Description
#62	Light effects modifications	0 - 9	0	Change of minimum dimming value (FX_MIN_DIM)
#63	Light effects modifications or Stop light OFF delay	0 - 99 0-255	51 (@ 5sec.)	Tens digit: sets cycle time (0 - 9, default 5), or start up time during soft start (0 - 0,9s) Ones digit: extends "off" time Ones digit with activated stop lights (value 56 in CV #125 - 132): If stop light is activated with value 56 in CV #125, 126 or 127: Time in tenths of a second (range: 0 - 25 sec.) the stop lights remain on after the street car comes to a full stop.
#64	Light effects modifications	0 - 9	5	Ditch light off-time modification
#133	Function output 2 as virtual cam sensor for external sound modules	0 - 255 MX62 - 64: from SW 25	0 (= FO2 defined as normal function output, not as virtual exhaust cam)	The pulse rate selected here is the exhaust chuff rate sent through function output 2 to the sound module, in place of an actual exhaust cam sensor mounted at the wheel. Also see chapter 7!  = 40 (Default): Approximately 2 pulses per wheel revolution of a typical LGB loco; although the actual frequency depends on the drive type and adjustments.  Adjustments: a smaller value in CV #133 results in higher frequency, a higher value decreases frequency. For example: CV #133 = 20 generates 4 chuffs per wheel revolution, a value of 40 generates 2.
#134	Asymmetrical threshold for stopping with asymmetrical DCC signal (Lenz ABC method).  MX63, MX64: beginning with SW-Version 25.  MX620: functional with first SW version.	1 - 14, 101 - 114, 201 - 214  = 0,1 - 1,4 V	106	Hundredths digit: Sensitivity adjustment, changes the speed with which the asymmetry is being recognized. = 0: fast recognition (but higher risk of errors, i.e. unreliable stopping). = 1: normal recognition (@ 0.5 sec.), pretty save results (default). = 2: slow recognition (@ 1 sec.), very reliable. Tenths and ones digit: Asymmetrical threshold in tenths of a volt.  This voltage difference between the half waves of the DCC signal is the minimum required to be recognized as asymmetrical that starts the intended effect (usually braking and stopping of a train). Also see CV #27!  = 106 (Default) therefore means 0.6 V. This value has proven itself to be appropriate under normal conditions; by using 4 diodes to generate the asymmetry, see chapter 4!

CV	Designation	Range	Default	Description
#135	km/h – Speed regulation - Activating, control and range definition  <b>Only MX620, MX64D!</b>	2 – 20  See chapter 4, „km/h – speed regulation“!	0	= 0: km/h – Regulation turned off; the "normal" speed regulation is in effect. Start with Pseudo-Programming („Pseudo“ = pro- grammed value is not being stored): CV #135 = 1 -> Initiates a calibration run (see chapter 4, „km/h – speed regulation“) Continue with "normal" programming of CV #135 (programmed value will be stored): = 2 to 20: speed steps / km/h – factor; e.g.: = 10: each step (1 to 126) represents 1 km/h: that is step 1 = 1 km/h, step 2 = 2 km/h, step 3 = 3 km/h, = 20: each step represents 2 km/h; step 1 = 2 km/h, step 2 = 4 km/h, last step 126 = 253 km/h. = 5: each step represents .5 km/h; step 1 = .5 km/h, step 2 = 1 km/h, last step 126 = 63 km/h.
#136	km/h – Speed regulation - Control number read-out <b>Only MX620, MX64D!</b>	See chapter 4, „km/h – speed regulation“!	-	A numeric value can be read-out after a successful calibration run, which was used to calculate the speed. This value is interesting because it is (al- most) independent from the selected speed during the calibration run. The uniformity of the resulting values from several calibration runs may be an in- dication of the calibration quality. See chapter 4!
#137	Deactivating the "HLU" direction bits  MX62, MX63, MX64: from SW-Version 25; MX620 later	Bits 0 - 2	0	The direction bits, added in 2006, are an extension of the ZIMO "signal controlled speed influence" ("HLU" method); the bits allow for direction de- pendent speed limit or stop section applications. <b>Explanations to "direction bits" are also found in the MX9 track section module manual.</b> Bit 0 = 1: ignores the „first direction bit“ Bit 1 = 1: ignores the „second direction bit“ Bit 2 = 1: accepts both direction bits. See chapter 11 for Bit value calculation!
#138	Direction depend- ent conversion of a stop (H) section to a "Go" section.  MX62, MX63, MX64: from SW-Version 25; MX620 later	0 - 8	0	A stop section H (=Halt) is interpreted as a "Go" section in the opposite direction: = 4: as „U“ = 5: Intermediate steps = 6: as „L“ = 7: Intermediate steps = 8: as „F“
#139	Direction depend- ent conversion of F, L, U.  MX62, MX63, MX64: from SW-Vers. 25; MX620 later	0 – 8 If ABC behavior is desired but with HLU method: CV #138 <u>and</u> 139 = „8“		A speed setting F, L, or U (or intermediate steps) is to be interpreted as stop "H" (=Halt): = 2 as „H“ = 4: as „U“ = 5: Intermediate steps = 6: as „L“ = 7: Intermediate steps = 8: as „F“

CV	Designation	Range	Default	Description
#140	Distance controlled stopping (constant stopping distance)  Select start of braking and braking process  MX62, MX63, MX64: from SW-Version 25!	0, 1, 2, 3, 11, 12, 13	0	Activates distance controlled stopping as per CV #141 in place of time-constant braking according to CV #4. = 1: automatic stops with "signal controlled speed influence" or "asymmetrical DCC signal". = 2: manual stops using the cab. = 3: automatic <u>and</u> manual stops. The start of braking is delayed in above cases (= 1, 2, 3), if the train travels at less than full speed to prevent an unnecessary long "creeping" (recom- mended). On the other hand: = 11, 12, 13 selection as above but braking starts always immediately after entering the brake sec- tion.
#141	Distance controlled stopping (constant stopping distance)  Distance calculation  MX62, MX63, MX64: from SW-Version 25!	0 - 255	0	This CV defines the "constant stopping distance". The right value for the existing stop sections has to be determined by trial. Use these figures as a starting point: CV #141=255 is about 1 scale-km (12m in H0), CV #141=50 about 200 m (2,4m in H0)
#142	Distance controlled stopping (constant stopping distance)  High-speed correc- tion using the ABC method  MX62, MX63, MX64: from SW-Version 25!	0 - 255	12	The delayed recognition (see CV #134) but also unreliable electrical contact between rail and wheels has a larger effect on a stop point at higher speeds than at lower speeds. This effect is cor- rected with CV #142. = 12: Default. This setting usually works fine if CV #134 is set to default also.
#143	... compensation using the HLU method  MX62, MX63, MX64: from SW-Version 25!	0 - 255	0	Since the HLU method is more reliable than the ABC method, no recognition delay is usually re- quired in CV #134; therefore this CV can also re- main at default setting 0.

CV	Designation	Range	Default	Description
#144	Programming and update lock MX62, MX63, MX64: from SW-Version 32, MX620, MX64D from SW-Version 7.	Bits 6, 7	0 or 255  (255 = „FF“, which for “old” decoders is the same as 0)	This CV was introduced to prevent unintentional decoder changes or loss of functions due to an inadvertent entry to the update mode. = 0: Unrestricted CV programming, Bit 6 = 1: No programming possible in <b>service mode</b> : protection against unintentional programming. Note: “on-the-main” programming is still possible. Bit 7 = 1: Software updates normally executed with the MXDECUP, MX31ZL or future devices are blocked.  (Unlock this CV with “on-the-main” programming)
#145	Alternative motor control method	0, 1 for MX620, MX64D  10, 11, 12 Only for MX64D, MX64DM with C-/Softdrive-Sinus	0	= 0: normal control mode (DC & coreless motors (Faulhaber, Maxxon)) = 1: special control for low-impedance DC motors (often Maxxon); this mode allows the connection of a capacitor (10 or 22uF) to the decoders positive and ground pads which puts less stress on the decoder and motor. = 10: “normal” C-Sinus and Softdrive-Sinus control mode (same as CV #112, Bit 0 = 1), FO4 is fixed and not available as a function output. = 11: alternative C-Sinus / Softdrive Sinus control mode, FO4 is available as normal function output (not suitable for all C-Sinus or Soft drive-Sinus equipped locomotives). = 12: special C-Sinus and Softdrive-Sinus control mode for interfaces requiring the normal motor output instead of the otherwise more common C-Sinus output, FO4 is fixed and not available as function output.
#146	Compensation for gear backlash during direction changes in order to reduce start-up jolt.  MX620, MX64D: from SW-Version 9 MX62, MX63, MX64: <u>not</u> available	0 - 255	0	A certain backlash between gears of a drive train is required to prevent them from binding. This backlash may be more severe on some engines than on others, especially when fitted with a worm gear. An engine with a worm gearbox also exhibits excessive backlash. Excessive backlash leads to a peculiar behavior especially when changing the direction: When the motor starts spinning in the opposite direction it doesn't move the engine because it has to eliminate the backlash first. Also, soon after it starts spinning it may enter the acceleration phase. When the motor finally starts to move the engine, the motor's speed has exceeded the normal start-up rpm, which results in an unpleasant jolt. This can be avoided with the help of CV #146. = 0: no effect = 1 to 255: the motor spins at minimum rpm (according to CV #2) for a specific time. Acceleration starts after that time has elapsed. This comes only in effect when a direction change has been per-

CV	Designation	Range	Default	Description
				formed previously. How much time is required to overcome the backlash depends on various circumstances and can only be determined by trial and error. Typical values are: = 100: the motor turns about 1 revolution or a maximum or 1 second at the minimum speed. = 50: about ½ a turn or max. ½ second. = 200: about 2 turns or max. 2 seconds. Important: CV #2 (minimum speed) has to be set correctly, that is the engine has to move with the lowest speed step (1 of 128 or 1 of 28). Also, CV #146 is only useful if the load regulation is set to maximum or at least close to it (i.e. CV #58 = 200 – 255).
#161	Servo outputs: Protocol for MX620, MX64D: from SW version 6 <b>MX62, MX63, MX64 are not equipped for servo actuation!</b>	0 - 3	0	Bit 0 = 0: Servo protocol with positive pulses. = 1: Servo protocol with negative pulses. Bit 1 = 0: Control wire active during movement = 1: ... always active (consumes power, vibrates at times but holds position even under mechanical load). Bit 2 = 0: Moves to center position if defined for two-key operation (see CV #181/182) when both function keys are OFF. = 1: Servo runs only if function keys are pressed when in two-key operating mode (see CV #181/182). <b>See chapter “Installation and wiring” for servo applications with the MX620 and MX64D!</b>
#162	Servo 1 Left stop	0 - 255	49 = 1 ms pulse	Defines the servo's left stop position.
#163	Servo 1 Right stop	0 - 255	205	Defines the servo's right stop position.
#164	Servo 1 Center position	0 - 255	127	Defines a center position, if three positions are used.
#165	Servo 1 Rotating speed	0 - 255	10 = 1 sec	Rotating speed; Time between defined end stops in tenths of a second (total range of 25 sec). Value “30” = 3 sec.
#166 to #169	As above for servo 2 <b>MX62, MX63, MX64: not equipped for servo actuation!</b>			

CV	Designation	Range	Default	Description
#181 #182	Servo 1 Servo 2  Function assignment	0 - 114  90 - 93 from SW- Version 7 (MX620, MX64D)	0 0	<p>= 0: Servo not in operation</p> <p>= 1: Single-key operation with F1</p> <p>= 2: Single-key operation with F2 etc.</p> <p>= 90: Servo action depends on loco direction: forward = turns left; reverse = turns right</p> <p>= 91: Servo action depends on loco stop and direction: turns right when stopped and direction is forward, otherwise turns left.</p> <p>= 92: Servo action depends on loco stop and direction: turns right when stopped and direction is reverse, otherwise turns left.</p> <p>= 93: Servo action depends on loco movement: turns right when loco stopped, left when loco moving; direction makes no difference.</p> <p>Note: "left/right" is determined by the stop point settings with CV #162 and #163!</p> <p>= 101: Two-key operation F1 + F2</p> <p>= 102: Two-key operation F2 + F3 etc. (left/right in each case)</p> <p>= 111: Two-key operation F11 + F12</p> <p>= 112: Two-key operation F3 + F6</p> <p>= 113: Two-key operation F4 + F7</p> <p>= 114: Two-key operation F5 + F8</p> <p>(Two-key mode operates as defined with CV #161, Bit 2)</p>
# 185	Special assignment for live steam engines	0, 1, 2		<p>= 1: Steam engine operated with single servo; speed and direction controlled with speed regulator, stop is in center position.</p> <p>= 2: Servo 1 proportional speed regulator, Servo 2 for direction.</p> <p>= 3: as in 2, but: direction-servo is automatically in "neutral" if speed is 0 and F1 is ON; If speed step &gt; 0: direction-servo is engaged.</p> <p>NOTE to CV #185 = 2 or 3: Servo 1 is adjustable with CV #162, #163 (end stops); with appropriate values the direction can be reversed as well. Servo 2 is adjustable with CV #166, #167.</p>

## 4. Additional notes to Configuration Variables (CV's)

### Optimal Control, Automated Stops, Effects . . .

#### Two ways of programming speed curves:

Programmable speed curves can often optimize the driving characteristics of an engine. These curves alter the relationship between the cab's speed regulator settings and the engines speed (that is between 14, 28 or 128 external speed steps of the cab and the 252 internal speed steps of the decoder).

Which one of the two speed curves the decoder applies is determined by Bit 4 of Configuration Variable #29: "0" assigns the first type - Three Step Programming, defined by just three CV's; "1" assigns the second type - Programmable Speed Table, defined by 28 individual CV's.

**Three step programming:** by using the Configuration Variables #2 for Vstart, #5 for Vhigh and #6 for Vmid. Vstart defines one internal speed step out of a total of 252 to the first speed step of the cab, Vhigh to the highest speed step and Vmid to the center speed step of the cab. In this way a simple bent acceleration curve can be achieved with an expanded lower speed range.

A slightly bent curve is active by default (CV #6 = 1), that is the center speed step is limited to 1/3 of full speed.

**Programmable speed table:** with the help of the programmable speed table, **free programming** of all **Configuration Variables** from #67 to 94 is possible. Each of the 28 external speed steps is assigned to one internal step (0 to 252). If 128 external speed steps are used, an interpolation algorithm is used to calculate the steps in between.

**NOTE:** The three step programming is in most cases entirely sufficient for good drivability; the relatively complex procedure of defining a speed table is only recommended with the help of software like ADaPT that graphically draws the speed curve and automatically sends the data to the decoder.

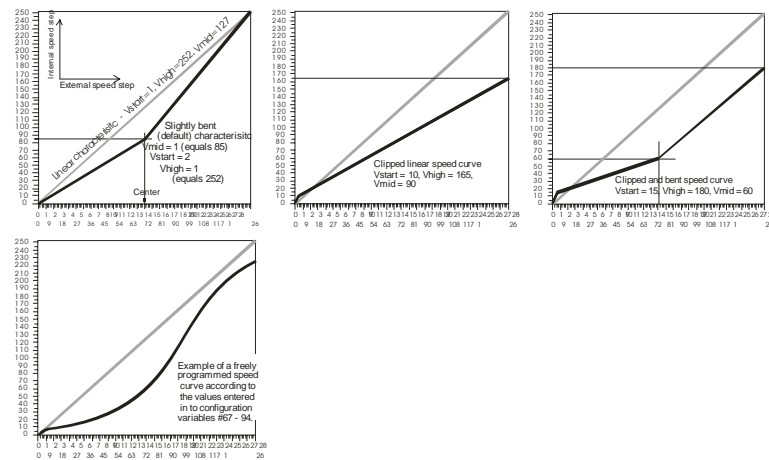

#### Motor control frequency and EMF scanning rate:

In case of **Faulhaber, Maxxon or similar** motors (Coreless):  
Start with special **CV #56 = 100** programming !!!

The **motor** is controlled by **pulse with modulation** that can take place at either low or high frequency. This frequency is selected with **configuration variable #9** (NMRA conforming formula, see CV table).

**High frequency control:** The motor is controlled at 20kHz in default mode or whenever a value of "0" is entered to CV #9, which can be raised to 40kHz with bit 5 in CV #112. The effect is comparable to operating with DC voltage and is likewise just as **noiseless** (no hum as with low frequency) and easy on the motor (minimum thermal and mechanical stress). It is ideal for coreless motors (recommended by Faulhaber!) and other high performance motors (most modern motors, including LGB). It is not recommended however, for AC motors and some older motors.

When operating at high frequency, power to the motor is interrupted periodically in order to determine the current speed by measuring back-EMF (voltage generated by the motor). The more frequently this interruption takes place, that is the higher the **EMF sampling frequency**, the better the load compensation performs (see next page); but that also results in a certain loss of power. This sampling frequency varies automatically in the default mode (CV #9 = 0) between 200Hz at low speed and 50 Hz at maximum speed. CV #9 allows the adjustment of the sampling frequency as well as the sampling time.

\* It is recommended in most cases where an improvement is still required for **MAXXON, Faulhaber or similar motors**, to select a lower sample frequency such as **CV #9 = 11, 12, 21, 22** etc after CV #56 was programmed to 100; this will in any case reduce motor noise!

\* for **older type motors** use rather the opposite, e.g. **CV #9 = 88**. Also see CV table and the following page!

**Low frequency control:** Entering a value between 176 and 255 to CV #9 drives the motor between **30 and 150 Hz**. Most often used value is 208 for 80 Hz. This is rarely used today and is only suitable for AC motors with field coils.

#### The load compensation:

All Zimo decoders come equipped with **load compensation**, also known as BEMF to keep a **constant speed**, regardless whether the engine is pulling a short or long train uphill, downhill or around a tight radius (although the speed will not be held 100% constant, especially in the upper speed range). This is accomplished by constantly comparing the desired value (speed regulator setting) and the actual value at the motor, determined with the EMF method (EMF stands for Electro Motive Force and is the force (power) produced by the motor when it is turned without power applied to it).

The **Reference Voltage** used for the BEMF algorithm can be defined by **configuration variable #57** as either absolute or relative (default).

##### Absolute Reference:

A voltage value is defined in CV #57 as a base line for the BEMF calculation. For example: if 14V is selected (CV value: 140), the decoder then tries to send the exact fraction of the voltage indicated by the speed regulator position to the motor, regardless of the voltage level at the track. As a result the speed remains constant even if the track voltage fluctuates, provided the track voltage (more precisely, the rectified and processed voltage inside the decoder, which is about 2V lower) doesn't fall below the absolute reference voltage.

The "absolute reference" is to be preferred to the "relative reference" when using other vendors' systems (particularly those that don't keep the track voltage stabilized!)

**Relative Reference:** The speed range is automatically adjusted to the available track voltage, if a 0 is entered to CV #57 (default). Therefore, the higher this voltage is set at the command station (adjustable between 12V and 24V) the faster the train will be over its entire speed range.

The relative reference is suitable as long as a constant voltage is present (which is the case with all Zimo systems but not all competitor systems) and the resistance along the track is kept to a minimum.

The driving characteristic of an engine can further be optimized by adjusting the **intensity of load compensation with CV #58**. The goal of load compensation, at least in theory, is to keep the speed constant in all circumstances (only limited by available power). In reality though, a certain reduction in compensation is quite often preferred.

100% load compensation is useful within the low speed range to successfully prevent engines from stalling or picking up speed under load. BEMF should rather be reduced as speed increases, so that at full speed the motor receives full power with little BEMF. A slight grade dependent speed change is often considered more prototypical. Consists also should never be operated with 100% BEMF because it causes the locomotives to fight each other by compensating too hard and too fast, which could lead to derailments.

The degree of load compensation can be defined with **Configuration Variable #58** from no compensation (value 0) to full compensation (value 255). This, in effect, is the amount of compensation applied to the lowest speed step. Typical and proven values are in the range of 100 to 200.

If an even more precise load compensation is required (though hardly ever necessary), **configuration variable #10 and #113** presents a solution. CV #10 defines a speed step at which the **load compensation is reduced to the level defined in CV #113**. Both CV's have to have a value other than 0. If either CV #10 or #113 is set to 0, BEMF is again solely based on CV #58.

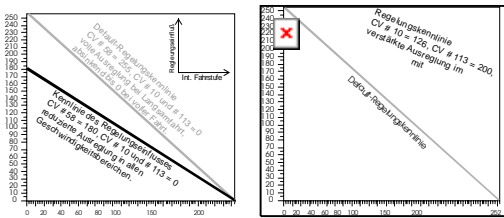

Regarding **configurations variable #56** – if proportional and integral values are set to default (zero) or “100” for coreless motors (Faulhaber, Maxxon etc) but drivability is not satisfactory:

See CV table and the following chapter on “Step by step.....”!

### Acceleration and deceleration characteristics (momentum)

**Configuration Variables #3 and #4** provide a way of setting a **basic linear acceleration and deceleration rate** according to NMRA rules and regulations. That is, the speed is changed in equal time intervals from one speed step to the next.

To simply achieve smooth transitions during speed changes, a value between 1 and 3 is recommended. The true slow starts and stops begin with a value of about 5. Programming a value higher than 30 is seldom practical!

The momentum can be modified with **Configuration Variables #121 and #122** to an **exponential acceleration and deceleration rate**, independent from each other. This in effect expands the momentum in the lower speed range. The area of this expansion (percentage of speed range) and its curvature can be defined.

A typical and practical value is “25” (as starting point for further trials).

The **adaptive acceleration and deceleration procedure** defined by **configuration variable #123** will not allow a change in speed until the previous target speed step of an acceleration/deceleration event is nearly reached.

Most often applied values are “22 or “11”, which can noticeably reduce a start-up jolt (the effect increases with smaller figures).

### Step by step CV adjustment procedure to optimize engine performance:

It is recommended to systematically program a decoder since setting the CV's for load compensation and momentum can result in a certain interaction with each other:

\* To begin, select the highest possible number of speed steps the system can operate in, that would be **128 steps** for Zimo (select the number of speed steps at the cab for the decoder address in question); other systems may operate only with 28 or 14 speed steps. All Zimo decoders operate by default with 28 /128 speed steps (both variants are utilized). If used with systems that are restricted to 14 steps set Bit 1 in CV #29 to 0.

\* Next set the engine to the lowest step, recognizable on the Zimo cab's when the bottom LED next to the speed slider changes color from red to green and/or the speed step 1 is displayed on the screen of the MX21/MX31 cabs (first, change the cab to 128 speed steps for this address, if not done so or if it isn't already the default setting!).

If the engine is now running to slow or not at all, increase the value in **CV #2** (default 2), if it runs too fast decrease the value. If the individual speed table is used (CV #67 - 94, active if bit 4 of CV #29 is set), set the lowest speed step with CV #67 instead and adjust the rest of the speed table CV's accordingly.

\* The EMF sampling process (see previous page) is critical for smooth even low speed behavior and quiet motor performance which can be modified with **CV #9**. This CV is also used to set the decoder to low frequency motor control, which is required only rarely with older AC motors.

By default (CV #9 = 0), the frequency is set to 20 kHz with Bit 5 of CV #112) and automatically adapts the EMF sample rate to the loco speed. If drivability is not flawless or too much motor noise is audible, fine-tuning is possible as follows:

CV #9 = 0 (default) has the same effect as when CV #9 = 55, that is a medium value for the ones as well as the tens digit. The value of the tens digit (1-9) in CV #9 determines the EMF sampling rate and the value of the ones digit (1-9) the EMF sampling time, which is the time the motor is not powered.

In general: High-efficient motors such as **Faulhaber, Maxxon, Escap** etc (coreless motors) can manage with short measuring times; the ones digit of CV #9 can therefore be set to a value of “2”. The ideal EMF sampling rate depends on the loco construction and weight: small, lightweight engines require a rather high sampling rate (i.e. “5”) while heavy engines (i.e. O-gauge or large HO engines) work well with a lower sampling rate (i.e. “2”). So for a typical HO engine with coreless motor (i.e. Faulhaber) a setting of **CV #9 = 52** is often a good choice; for O-scale **CV #9 = 22**. Further improvements in terms of smooth low speed performance and reduced motor noise may be achieved by trial and error using different tens digit values in CV #9; and of course by means of CV #56 (see below).

If an engine with an **older motor design** runs rough at low speeds, the sample frequency (tens digit) is usually the one that needs to be set to a larger value (>5), which often requires the sample time (ones digit) to be set to a higher value as well (>5); i.e. CV #9 = 88.

\* If, after setting CV #9, the engine still doesn't run smoothly enough at the lowest speed step, changing the values of the ones and tens digit in **CV #56** will often improve it. Here also, the default value of “0” is equal to the center setting of 55. These values define the proportional and integral portion of the PID control. By default (CV #56 = 0), the proportional value adjusts itself automatically and the integral value is set to mid-value. Depending on the type of motor, other values than the default value can be used, such as 77, 88 or 99 for older locos that run rough or 33, 22, or 11 for newer locos with more efficient motors (Faulhaber, MAXXON etc).

A possible overcompensation can be reduced with the help of the integral value (ones digit of CV #56).

For engines with **Maxxon, Faulhaber** (coreless motors) the setting **CV #56 = 100** should be tried first (instead of the default “0” for normal DC motors). This setting is equal to CV #56 = 155, where the hundreds digit “1” is an adjustment to the center setting for highly efficient motors. If necessary, further improvements may be achieved by different values of the tens and ones digit.

\* After improving low speed performance (by increasing the value of CV #56 described above), check that the engine is not running jerkily at mid-speed level that could be caused by high CV #56 values (77, 88...). This effect can be compensated for by reducing the total amount of load compensation in **CV #58** (default "250") down to "200" or "150" or use CV #10 and #113 to cut the load compensation at a speed just below the start of the jerky motion (the compensation is reduced to the level defined with CV #113 at the speed step defined with CV #10).

\* If after the above adjustments the engine's speed is still fluctuating, use **CV #57** for further fine-tuning. With a default value of 0, load compensation is based on the measured track voltage. If this voltage fluctuates, the speed will also fluctuate. The cause is usually a DCC system that can't compensate for voltage drops (other than Zimo systems) or dirty wheels or track. To prevent such fluctuations a value representing the selected track voltage x10 is entered to CV #57 (not idle track voltage, rather voltage under load). For example, if an engine needs 14 V (measured under load) a value of 140 should be entered. Sometimes it's even better to keep this value about 20% to 50% lower to compensate for a slight internal voltage drop in the decoder.

\* Next, we check to see whether the loco's initial start is smooth or abrupt. This can be seen well with some momentum added. Temporarily, set some momentum with CV #3 and #4. Start with a value of 5.

There are basically two different kinds of start up jolts: the jolt that happens every time an engine starts up and the one that only shows up after the engine changes direction (i.e. after the engine stopped, changed direction and starts up again). The "direction-change jolt" is due to gearbox backlash; see further down.

The adaptive acceleration procedure can now be used to eliminate abrupt starts by changing the value in **CV #123**. Start with a value of 20. The lower the value, the stronger the effect will be (e.g. 10 results in the strongest effect for acceleration, 90 the weakest).

A possible jolt when stopping can also be reduced with the help of the ones digit. The tens digit is for defining the adaptive acceleration and the ones digit for the adaptive deceleration. CV #123 = 22 improves the start-up as well as the stop jolt. It may be of advantage to reduce the adaptive deceleration, i.e. CV #123 = 24 in order to improve repeatable stop points in automated operations (routes, block control etc.).

With MX620, MX64D and MX64P decoders, beginning with SW version 9, the "direction-change jolt" can also be reduced using **CV #146**. Typical values are CV #146 = 50 or 100. See CV table.

\* After changing the values in CV #123 the basic momentum may need to be readjusted to your preferences; first with **CV's #3 and #4** (basic momentum). Usually higher than default values should be used, at least CV #3 = 5 and CV #4 = 3. This improves the engine's performance considerably. Much higher values are suitable for engines equipped with sound in order to match the sound to the engine's movement (with sound decoders as well as external sound modules via SUSI).

Additionally the "exponential acceleration and deceleration" may be applied with **CV #121** and **#122**. This allows for prototypical non-linear momentum coupled with extremely soft starts and stops without compromising the maneuverability in the upper speed range. This stretches the time the locomotive will spend in the lower speed range. Often used values for these CV's are between 25 and 55, which means that 20% to 50% (according to the tens digit) of the total speed range will be included in the exponential acceleration curve, with a medium curvature (ones digit at '5').

**Notes on acceleration behavior versus speed steps:**

An acceleration or deceleration sequence according to CV #3 and 4 that is the timely succession of speed steps is always based on the internal 252 steps which are spaced identical from 0 to full speed. Neither speed table (three steps nor individual speed table) has any effect on the acceleration or deceleration behavior. The speed tables only define the target speed for a particular speed dialed-in by the cab.

This means that the acceleration or deceleration behavior cannot be improved by a bent speed curve as defined by CV #2, #5, #6 or the individual speed table CV's #67 - 94. The exception to this could only be a cab or computer controlled acceleration or deceleration event. A desired curve in a decoder controlled acceleration or deceleration event however is possible with the "exponential acceleration/deceleration" using CV #121 and #122.

- If applicable see section "Settings for the signal controlled speed influence"!
- If applicable see section "Setting for stopping with ..."!
- If applicable see section "Distance controlled stopping" (constant stopping distance)!

**Case studies of practical CV programming:**

The fine-tuning of a locomotive is not difficult but represents uncharted territory for many users. The following is meant to **assist you with actual programming cases**, which were performed by ZIMO at customer's or locomotive manufacturer's requests or by close ZIMO partners.

The tuning of a locomotive reflects in part the personal preferences of an individual but must also take into account the special circumstances of its intended application; still valid suggestions can be drawn from it.

It must be pointed out that there can be significant mechanical deviations among mass-produced locomotives even among identical models but even more so between different models, so that further fine-tuning can be of advantage (although it is often not really necessary).

**Roco loco of modern design (about 1995 and up) / Original-Roco-Motor**

Such locomotives are operating very good even with the decoder's default settings, which is also due to the fact that these locomotives are often used as reference during the ZIMO decoder software development.

The settings below are recommended when used with **non-ZIMO command stations**:

CV #57 = xx, i.e.  
= 120 (12 V) or  
= 140 (14 V) or  
= 150 (15 V) etc.  
as track voltage under load, but not higher than that.

Setting CV #57 to a specific value (i.e. CV #57 = 120) differs from the default setting (CV #57 = 0) in as much as the top speed no longer depends on the current track voltage, provided the track voltage is high enough. For example, if track voltage is >12V and CV #57 set to 120, the decoder regulates top motor speed to 12V.

This is an advantage if the **command station is not from ZIMO**, because most of them don't regulate track voltage. There is no difference within a ZIMO system because the track voltage is kept constant (with the exception of voltage drops along the track, due to poor layout wiring). A disadvantage of using CV #57 with a specific value is that the value used has to be in relation to the actual track voltage, which is a manual intervention whereas CV #57 = 0 is self-regulating.

CV #57 is also suitable for limiting top speed, alternatively to CV #5 and can of course also be utilized with ZIMO systems. For example: CV #57 = 130 and a track voltage of 18V will reduce the overall speed (all speed steps) by about 25%.

CV #3 = 2 (> 2)  
CV #4 = 2 (> 2)  
CV #121 = 11 (>)  
CV #122 = 11 (>)

A minimal value of "2" in CV #3 and #4 eliminates visible speed changes between speed steps but has not much to do with prototypical momentum, which requires much higher values. Higher values (i.e. CV #3 and #4 = 6, CV #121 and #122 = 33), depending on operating situations and personal taste, are recommended.

**Fleischmann locomotive with „Round motor“**

The “Round motor” has been Fleischmann’s standard motor until today (2007); a small readjustment of the CV values is appropriate.

Furthermore ... especially on these motors it is recommended to **remove or bypass the built-in filtering components** such as choke coils and capacitors. Attention: often the “worst” capacitor is the one that is least visible and/or accessible.

CV #56= 33, 44....	It has been demonstrated that reducing the P and I regulation of the BEMF function is beneficial for the “Round motor” (#56 < 55, which is lower than the default value). There is no need to modify CV #9.
CV #57 = xx ...	See above („Roco Loc“) !
CV #3 = 2 (> 2) CV #4 = 2 (> 2) CV #121 = 11 (>) CV #122 = 11 (>)	These recommendations are true here as in almost all other cases (see above “Roco Loc”).

**NMJ Superline NSB Skd 2220c (small Norwegian switcher engine, built in 2007)**

Product of Norsk Modeljernbane, with **Faulhaber-Motor**,

**MX63**, with SW based on the version 30, is being installed at the factory; this decoder contains special software with a hard reset procedure that sets the decoder back to optimized CV values, similar values as are listed here.

This engine served in the development of the **regulated analog control!**

ZIMO decoders are very well suited for Faulhaber motors, even with the default settings. An even better result can be achieved with the special Faulhaber setting in CV #56.

CV#9 = 12	That means shorter EMF measuring time and smaller frequency, which leads to reduced noise and extremely low crawling speed.
CV#56 = 155	That means Faulhaber typical measuring time (“1”), medium P/I regulation.
CV#57 = xx ...	See above under “Roco Loc”.
CV#112 = 0 That is: Bit 2 = 0, all other Bits are already at 0 by default.	ZIMO loco number ID (Bit 2 = 0) turned off, which by default is turned on (Bit 2 = 1, that’s why CV #112 = 4). This prevents small ticking sounds (audible in metal locomotives).  This preventive step is only of significance in conjunction with a ZIMO DCC system, because no loco number pulses are produced in other systems (and therefore no ticking sounds can be heard). If on the other hand the loco number identification within a ZIMO systems is being used (MX9 modules with MX9AZN boards), the loco number pulses must of course not be turned off!
CV#3 = 2 (> 2) CV#4 = 2 (> 2) CV#121 = 11 (>) CV # 122 = 11 (>)	These recommendations are true here as in almost all other cases (see above, “Roco Loc”).

**Philotrain, 3-part multi unit (Built in 2007)**

Product of Philotrain, with **Faulhaber motor**,

**MX64V1**, with SW based on the version 30, installed by the manufacturer.

Three part multi unit with low voltage headlight and interior light bulbs; for this reason a MX64V1 with 1.5V low voltage supply for function outputs is being used. The train runs pretty well with a ZIMO decoder as is; although a few changes are beneficial.

CV #9 = 13	Shorter EMF measuring time and smaller frequency, which leads to reduced noise and extremely low crawling speed.
CV #56 = 133	That means Faulhaber typical measuring time (“1”), a little less than medium P/I regulation (both digits “3” instead of “5”) results in best drivability.
CV #57 = xx ...	See above under “Roco Loc”.
CV #3 = 2 CV #4 = 2 CV #121 = 11 CV #122 = 33	These settings largely correspond to the general recommendations (see above under “Roco Loc”; only the range of the “exponential braking” (CV #122) was increased, which together with CV #123 results in smooth stops.
CV #123 = 95	The “adaptive acceleration” (“9”) is used here very sparingly (to prevent a start-up jolt), the “adaptive deceleration” (“5”) on the other hand a little stronger; this is - together with CV #122 (see line above) – practical, otherwise it could easily happen that the train, due to the motor’s momentum, at first isn’t slowed down fast enough and then suddenly is stopped too fast. The adaptive deceleration adapts the brake response to the mechanical possibilities: The braking distance increases and the locomotive comes to a smooth stop.
CV #112 = 0 That is: Bit 2 = 0, all other Bits are already at 0 by default.	ZIMO loco number ID (Bit 2 = 0) turned off, which by default is turned on (Bit 2 = 1, that’s why CV #112 = 4). This prevents small ticking sounds (audible in metal locomotives).  This preventive step is only of significance in conjunction with a ZIMO DCC system, because no loco number pulses are produced in other systems (and therefore no ticking sounds can be heard). If on the other hand the loco number identification within a ZIMO systems is being used (MX9 modules with MX9AZN boards), the loco number pulses must of course not be turned off!

<p><b>Märklin 8350 / SBB Series 460 / Maxxon-Motor 25260</b>                  Märklin-Product, upgraded with Maxxon motor 25260 (13 mm diameter) by SB-Modellbau.</p> <p>NOTE: the motor used in this heavy model is actually a little under powered and the flywheel is extremely small. For this reason, this locomotive is one that is difficult to control and CV tuning is more important than usual. Even after the fine tuning a certain problem persists during downhill runs, where the locomotive tends to buck a little. Compared to other products, ZIMO decoders manage this locomotive with its motorization quite well (whereby the MX620 is better than the MX64). It is likely that with future control algorithm (SW versions in the coming month and years) a further perfection level may be achieved.</p> <p>The attainable drivability especially in the extreme low speed range and the reaction to quick load changes are marginally better with the MX620 than with the MX64. This seems astounding considering the large and heavy engine, but might be due to the rather small motor (see above) with the characteristics of an N rather than an HO motor (the MX620 is designed for N-scale motors). Furthermore, an innovative automatic optimization of control parameters is in use, which has not (yet) been implemented in the MX63/MX64.</p>	
<p>Equipped with <b>MX64, SW version 30 (March 2007)</b>, favorable CV values are:</p>	
CV #9 = 61	Increased EMF frequency, shortened EMF measuring time (typical coreless)
CV #56 = 199	Faulhaber-typical measuring time ("1"), full P/I regulation.
CV #57 = 130	Reduced speed range to about 12V motor voltage.
CV #3 = 3 (> 3) CV #4 = 3 (> 3) CV #121 = 11 (>) CV #122 = 11 (>)	Momentum in CV #3 and #4 should not be much smaller than "3" so that good starting and stopping behavior is still possible; the exponential acceleration/deceleration improves starting and stopping further; still higher values for these variables (i.e. CV #3, #4 = 6, CV #121, #122 = 33) according to operational circumstances and personal taste correspond to even more realistic operations.
CV #123 = 33	Adaptive acceleration and deceleration (medium application) reduces start-up jolt and smoothes out stops.
<p>Equipped with <b>MX620, SW version 3.1 (Nov. 2006)</b>, favorable CV values are:</p>	
CV #9 = 61	Increased EMF frequency, shortened EMF measuring time (typical coreless)
CV #56 = 141	Faulhaber-typical measuring time ("1"), low P regulation because the MX620 regulates automatically, reduced I regulation.
CV #57 = 120	Reduced speed range to about 12V motor voltage.
CV #3 = 3 (> 3) CV #4 = 3 (> 3) CV #121 = 11 (>) CV #122 = 11 (>)	Momentum in CV #3 and #4 should not be much smaller than "3" so that good starting and stopping behavior is still possible; the exponential acceleration/deceleration improves starting and stopping further; still higher values for these variables (i.e. CV #3, #4 = 6, CV #121, #122 = 33) according to operational circumstances and personal taste correspond to even more realistic operations.
CV #123 = 52	Low intensity for adaptive acceleration ("5") because start-up acceleration with values <5 may be hindered and uneven. Stronger intensity for adaptive deceleration ("2") for smoother stops.

<p><b>Fleischmann Steam Engine BR55 4155</b> <span style="float: right;"><b>HO Gauge</b></span>  <b>MX620, with SW version 9.</b></p> <p>About the decoder: With SW version 9 (July 2008) driving characteristics were significantly improved for "difficult" engines while at the same time the influence of built-in interference components were reduced (although their removal might still be the better option).</p> <p>The following information is valid only for SW version 9 (and presumably later versions).</p>	
CV # 2 = 10	CV #2 is not set to achieve the absolute lowest possible speed but rather for a smooth running engine at the lowest speed possible; this is also of importance with the newly introduced (SW version 9) prevention of the "direction-jolt" per CV #146.
CV # 9 = 85	Increased EMF sampling rate to reduce jerky motion a slow speeds.
CV # 56 = 33	Slightly reduced proportional and integral regulation.
CV # 146 = 50	This takes care of the gear backlash: the motor turns about a half a turn at idle before it starts to move the wheels. The setting of CV #146 = 50 prevents the motor speed from being raised during this time, which results in a smooth start.
CV # 3 = 3 CV # 4 = 3 CV # 121 = 11 CV # 122 = 11	These settings correspond to the general recommendations.

<p><b>Tillig Diesel Engine BR218 02703</b> <span style="float: right;"><b>TT Gauge</b></span>  <b>MX620, with SW version 9.</b></p> <p>About the decoder: see above ("difficult" engine such as Fleischmann BR55)!</p> <p>The following information is valid only for SW version 9 (and presumably later versions).</p>	
CV # 2 = 10	See above (Fleischmann BR55)!
CV # 9 = 63	Slightly increased EMF sampling rate to reduce jerky motion a slow speeds, shorter EMF sampling time.
CV # 56 = 55	Default setting.
CV # 146 = 180	This takes care of the gear backlash: the motor turns almost 2 (!) turns at idle before it starts to move the wheels. The setting of CV #146 = 180 prevents the motor speed from being raised during this time, which results in a smooth start.
CV # 3 = 3 CV # 4 = 3 CV # 121 = 11 CV # 122 = 11	These settings correspond to the general recommendations.

<b>PIKO Siemens Dispolok ES64</b>		<b>TT Gauge</b>
<b>MX620, with SW version 9.</b>		
About the decoder: see above ("difficult" engine such as Fleischmann BR55)!		
The following information is valid only for SW version 9 (and presumably later versions).		
CV # 2 = 15	See above (Fleischmann BR55)!	
CV # 9 = 85	Increased EMF sampling rate to reduce jerky motion a slow speeds, default ("5") sampling time.	
CV # 56 = 33	Slightly reduced proportional and integral regulation.	
CV # 146 = 60	This takes care of the gear backlash: the motor turns about ½ a turn at idle before it starts to move the wheels. The setting of CV #146 = 60 prevents the motor speed from being raised during this time, which results in a smooth start.	
CV # 3 = 3 CV # 4 = 3 CV # 121 = 11 CV # 122 = 11	These settings correspond to the general recommendations.	

<b>Fleischmann piccolos 7355</b>		<b>N scale</b>
<b>MX620, with SW version 9.</b>		
The following information is valid only for SW version 9 (and presumably later versions).		
CV # 2 = 4	Slightly raised start-up voltage, which is of advantage for good performance.	
CV # 9 = 92	Increased EMF sampling rate to reduce jerky motion a slow speeds, reduced ("2") sampling time.	
CV # 56 = 55	Default setting.	
CV # 146 = 110	This takes care of the gear backlash: the motor turns about one turn at idle before it starts to move the wheels. The setting of CV #146 = 110 prevents the motor speed from being raised during this time, which results in a smooth start.	
CV # 3 = 3 CV # 4 = 3 CV # 121 = 11 CV # 122 = 11	These settings correspond to the general recommendations.	

## Km/h – Speed regulation - CALIBRATION and operation

MX620, MX64D  
and MX64V only!

The km/h speed regulation is a new, alternative method of **driving with prototypical speeds** in all operating situations: the cab's speed steps (1 to 126 in the so-called "128 speed step mode") will be directly interpreted as km/h. Preferably all engines of a layout should be set to the same method. Engines equipped with non-ZIMO decoders can be set up similarly through the programmable speed table (although with more effort and less precise because there is no readjustment taking place by the decoder).

**The ZIMO readjustment:** the decoder is not limited to converting the speed steps to a km/h scale but rather ensures that the desired speed is held, by recalculating the already traveled distance and automatically readjusts itself.

### A CALIBRATION RUN; should be performed with each loco:

First, we need to determine the **calibration track**: a section of track that measures 100 scale meters (plus the necessary length before and after, for acceleration and deceleration), of course without inclines, tight radii and other obstacles; for example, for HO (1:87) 115cm; for G-scale (1:22.5) 4.5m. Start and end points of the calibration distance need to be marked.

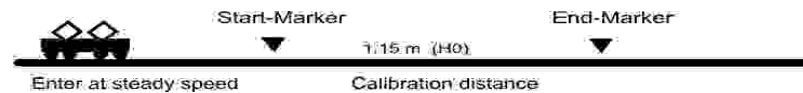

\* Set the loco on the track, with the proper travel direction selected, about 1 to 2 meters before the start marker and the function F0 (headlights) **turned off**. Acceleration times (momentum in CV #3 of the decoder as well as settings in the cab) should be set to 0 or a small value to prevent any speed changes inside the calibration distance. Otherwise, the length of track before the calibration marker needs to be increased accordingly.

\* The calibration mode is now activated by programming **CV #135 = 1** (operational mode programming). This is a pseudo-programming because the value of 1 does not replace the value already stored in CV #135.

\* Move the speed regulator to a **medium speed** position (1/3 to 1/2 of full speed); the loco accelerates towards the start marker.

\* When the engine passes the **start marker**, **turn on** the function **F0** (headlights); **turn F0 off** again when passing by the **end marker**. This ends the calibration run and the loco may be stopped.

\* CV #136 can now be read out for checking purposes. The calibration "result" stored in that CV doesn't mean very much by itself. If however, several calibration runs are performed, the value in CV #136 should approximately be the same every time, even if the traveling speed is varied.

### Km/h speed regulation in operation:

**CV #135** defines whether the "normal" or km/h operating mode is in use:

CV #135 = 0: The engine is controlled in "normal" mode; a possible km/h calibration run performed earlier has no effect but the calibration results remain stored in CV #136.

CV #135 = 10: each speed step (1 to 126) becomes 1 km/h: that is step 1 = 1 km/h, step 2 = 2 km/h, step 3 = 3 km/h ... to step 126 = 126 km/h

CV #135 = 5: each speed step (1 to 126) becomes 1/2 km/h: that is step 1 = .5 km/h, step 2 = 1 km/h, step 3 = 1.5 km/h, ... to step 126 = 63 km/h (for local or narrow gauge railways!)

CV #135 = 20: each speed step (1 to 126) becomes 2 km/h: that is step 1 = 2 km/h, step 2 = 4 km/h, step 3 = 6 km/h, .to step 126 = 252 km/h (High speed trains!)

The speed regulation in km/h is not just useful for direct cab control, but also in speed limits through the "signal controlled speed influence" (CV's 51 – 55). The values entered to those CV's are also being interpreted in km/h.

### Mph speed regulation:

A mph speed regulation can be achieved by extending the calibration distance accordingly!

### Note:

Operating with the km/h speed regulation causes constant readjustments in order to keep the travel distance to be covered as exact as possible. This is an **innovative control system** that has never been applied before by ZIMO or any other manufacturer and has undergone little testing. Some unplanned inconsistencies may very well pop up that may need to be corrected with a later software version (do-it-yourself update of new software possible with MXDECUP module).

## Settings for the ZIMO "signal controlled speed influence" (HLU)

ZIMO digital systems offer a second level of communication for transmitting data from the track sections to engines that are in such sections. The most common application for this is the "signal controlled speed influence", that is the stopping of trains and applying of speed limits in 5 stages issued to the track sections as required with the help of MX9 track section modules or its successors. See ZIMO flyers at [www.zimo.at](http://www.zimo.at) and MX9 instruction manual.

The term "**HLU**" **method** was coined over the years after the speed limit designation "H" (=Halt or stop), "L" (=Low speed) and "U" (Ultra low speed). Beginning with SW version 25 (MX62, MX63, MX64) it will also work independent of direction, which may be useful in many situations! See CV's #137 – 139 in the CV table.

\* If the "signal controlled speed influence" is being used (only possible within a ZIMO system), the speed limits "U" and "L" (and the intermediate steps if need be) can be set with configuration variables #51 to #55 as well as acceleration and deceleration values (momentum) with CV #49 and #50 (see CV table).

Please note that the signal controlled acceleration and deceleration times are always **added** to the times and curves programmed to CV #3, 4, 121, 122 etc. Signal controlled accelerations and decelerations compared to cab controlled momentum can therefore progress either at the same rate (if CV #49 and #50 is not used) or slower (if CV #49 and/or #50 contain a value of >0), but never faster.

It is of utmost importance for a flawlessly working train control system using the signal controlled speed influence that the stop and related brake sections are arranged properly everywhere on the layout, especially in terms of their length and consistency. Please consult the MX9 instruction manual and the STP manual.

The braking characteristics should be set up on a suitable test track so that all locos come to a complete stop within about 2/3 of the stop section, which is in HO typically about 15 to 20 cm before the end of a stop section (deceleration rate adjusted with CV #4 and CV #50 as well as the reduced speed with CV #52 for "U"). Setting the loco up to stop precisely within the last centimeter of a stop section is not recommended because such an exact stop point is, for various reasons, hardly repeatable every time.

### Settings for stopping with "asymmetrical DCC signal" (Lenz ABC)

MX63, MX64 from SW version 25.  
 MX620, MX64D with first SW version.  
**Not in MX62 !**

The "asymmetrical DCC signal" is an alternative method for stopping trains at a "red" signal, for example. All that is required is a simple circuit made up of 4 or 5 commercially available diodes.

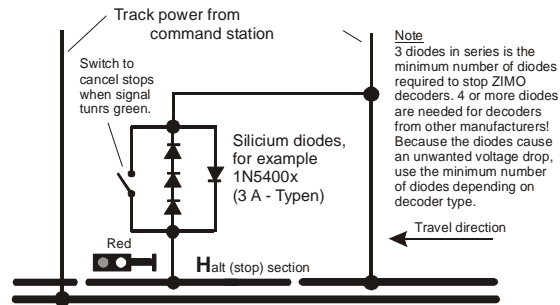

3 diodes in series (4 when using Schottky diodes) and one in opposite direction in parallel is the usual arrangement. The different voltage drops across the diodes results in an asymmetry of about 1 to 2V. The direction in which the diodes are mounted determines the polarity of the asymmetry and with it the driving direction a signal stop is initiated.

The asymmetrical DCC signal stop mode needs to be activated in the decoder with CV #27. Normally bit 0 is set, that is CV #27 = 1, which results in the same directional control as the "Gold" decoder from Lenz.

The asymmetrical threshold can be modified with CV #134 if necessary, default is 0.4V. At the time of writing, the "asymmetrical DCC signal" has not been standardized and many DCC systems pay no attention to this feature!

### Distance controlled stopping – Constant stopping distance

MX62, MX63, MX64 from SW version 25.  
 MX620, MX64D, MX64P with first SW version.

When this feature is selected with CV #140 (= 1, 2, 3, 11, 12, 13) it keeps the stopping distance as close as possible to the one defined in CV #141, independent of the speed when entering the stop section.

This method is especially suitable in connection with automated stops in front of a red signal with the help of the **ZIMO signal controlled speed influence** or the **asymmetrical DCC-signal** (see above). CV #140 is set for this purpose to 1 or 11 (see below for details).

Although of lesser practical value, the distance controlled stopping can also be activated directly by the cab or computer when the speed is set to 0 (by programming CV #140 with appropriate values of 2, 3, 12 or 13).

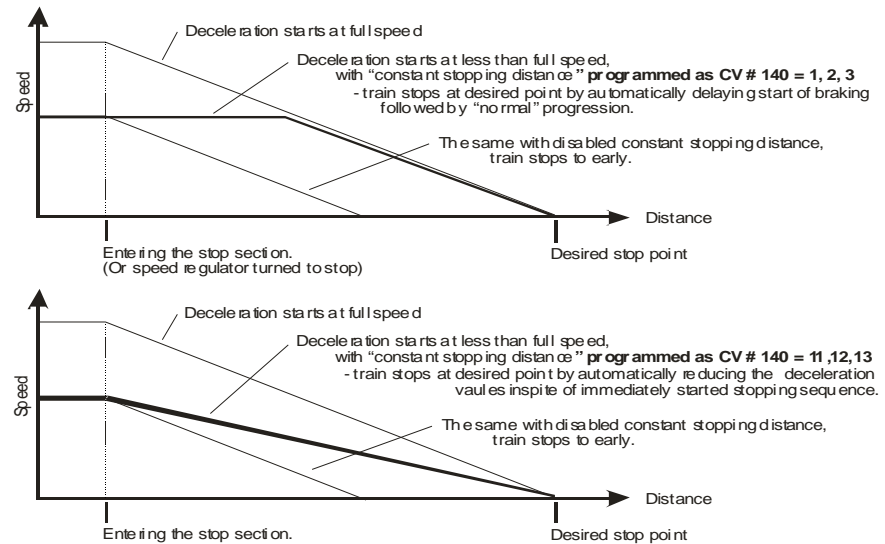

The distance controlled stopping can take place in two possible ways; see diagram above: **The first** is the **recommended method (CV #140 = 1, etc.)**, where the train entering at less than full speed continues at first at the same speed before it starts braking at a "normal" deceleration rate (same rate as would be applied at full speed).

In the second method (CV #140 = 11, etc.), the train immediately starts with the braking procedure, which may lead to an un-prototypical behavior. It may however be useful to use this method if used together with decoders from other manufacturers that do not have this capability in order to harmonize the brake sequences.

Also, the second method may be the preferred method if distance controlled stopping is used manually (CV #140 = 2 or 12), so that the train reacts immediately to speed changes.

*"Distance controlled stopping", when activated, is exclusively applied to decelerations leading to a full stop. Reductions in speed or acceleration events are not affected by this (still handled by CV #4 etc.).*

The traveled distance is constantly being recalculated in order to get as close as possible to the desired stop point. The deceleration rate within distance controlled stopping is always applied exponentially, that is the deceleration rate is high in the top speed range followed by gentle braking until the train comes to a full stop; which is *not* controlled by CV #122! The application of CV #121 for exponential acceleration however remains unchanged.

**Automated uncoupling procedure;  
also see “connecting an electric coupler” in chapter 7:**

*MX62, MX63, MX64 from SW-Version 25.  
MX620, MX64D, MX64P with first SW version.*

As described in chapter 7, the control of an electric coupler (System Krois) is defined by CV's #127, 128 etc. (function output effects) and CV #115 (timing).

With the help of CV #116 the decoder can be programmed so that the uncoupling loco automatically moves away from the adjoining coupler without moving the speed regulator (which is sometimes inconvenient because the uncoupler key needs to be pressed at the same time).

The tens digit in CV #116 defines **how long (0.1 to 5 sec)** the loco should move away from the adjoining coupler, the ones digit defines **how fast (internal speed step 4 to 36)** it should move away, see CV table. The momentum used during this acceleration/deceleration event is governed as usual by the relevant CV's (#3, #4 etc.). The hundreds digit of CV #116 causes the loco to automatically **push against the adjoining coupler before** the uncoupling process starts in order to relieve coupler tension (otherwise the couplers can't open).

Other hints:

- The procedure is activated if the tens digit in CV #166 is other than 0!
- The procedure (acceleration) takes place at the moment the coupler is activated, although only if the loco is at rest at the time of coupler activation (speed regulator in 0 position).
- When the procedure is activated (with the tens digit of CV #116), the coupler remains open during the defined time in CV #115 (not just for the duration the function key is pressed); it is therefore sufficient to press the function key just briefly to start and execute the whole uncoupler procedure (the function key used for the uncoupler function should of course be set as momentary key).
- If the uncoupler key is pressed again during the uncoupling and disengagement process, the process is stopped. This allows to correct directional errors but also to activate the coupler for testing purposes without starting the disengagement process.
- If the speed is changed during an automated uncoupling procedure, the process is also stopped.
- The driving direction during coupler detachment is always according to the cab setting; directional settings in the “Effects” definition for uncoupling (Bits 0 and 1 of CV #127, CV #128 etc.) will not be applied.

**Shunting and half-speed functions:**

By defining the different Configuration Variables (#3, 4, 121, 122, 123), a prototypical acceleration and deceleration behavior is achieved that often makes shunting very difficult.

With the help of CV #124, a shunting key can be defined (either the dedicated MAN key within a ZIMO system or the keys F4 or F3) with which the acceleration and deceleration rates may be reduced or eliminated all together.

CV #124 may also be used to define either F7 or F3 as low gear key. With this function turned on, the throttle is used for half the decoder's full speed range, which is just like shifting down into low gear.

Example: The F7 key should act as low gear and the F4 key should reduce the momentum down to ¼. According to the CV table, the bits in CV #124 are to be set as follows: Bit 0 = 0, Bit 1 = 1, Bit 2 = 1 and Bit 3 = 1. The sum of the individual bit values (0+2+4+8 = 14) is entered as a decimal value.

**“On-the-fly” - programming (a.k.a. on-the-main):**

Configuration variables can also be changed on the main track as well as on the programming track, without interfering with other trains operating on the layout.

All CV's, with the exception of address CV's, can be modified on the main. Please note though that the verification and read-out of CV values will not be possible until the bidirectional communication is implemented (in the course of 2006 with SW updates for the ZIMO command stations “model 2000” and MX1EC as well as decoders).

If no bidirectional communication is available, “on-the-fly” programming should primarily be used for CV's where a change is immediately visible (e.g. Vstart, Vmax, signal controlled speed influence settings, etc). Don't use it to program the 28 speed steps in the speed table for example, which is preferably done at the programming track (where programming can be confirmed through acknowledgments).

Consult the ZIMO cab instruction manual for on-the-fly programming steps!

## 5. "Function mapping" as per NMRA Standard; and ZIMO - Extensions

### *The allocation of function outputs ("function mapping"):*

Depending on decoder type, ZIMO decoders have between 4 and 14 function outputs (FO ...). The loads connected to these outputs, such as headlights, smoke generator etc. are switched on and off with the function keys (F...) of the cab.

Which key (F...) controls which function output (FO...) can be specified by a series of Configuration Variables.

The configuration variables #33 to #46 forms the NMRA function mapping according to their rules and regulations see table on the right.

A slightly modified function mapping that still conforms to the NMRA standard is used in the MX620 making use of the fact that the MX620 has a maximum of 6 function outputs (headlights, FO1, FO2 and with the SUSI interface deactivated additionally the logic level outputs FO3 and FO4), see table on next page!

In any case, the NMRA function mapping restricts the free allocation of function outputs and only the headlight function is intended for directional control

Therefore:

**Extended flexibility and more directional controlled functions are offered by ZIMO through configuration variable #61:**

**MX62, MX63, MX64:**

A number of ZIMO special function allocations CV #61 = 1 ... 6 allow among others directional taillights or the special lighting for Swiss electric and diesel engines. See next page!

**Alternative „function mapping“ without “left shift” with CV #61 = 97** allows higher function outputs to be mapped to lower function keys (see next page).

**(Only) MX620, MX64D and MX64P:**

With a special programming procedure CV #61 = 98 a procedure is started with which each function/direction command can be assigned to specific function outputs (e.g. F... – forward/reverse). A future addition is planned that allows the definition of an automated turn-off feature, which turns designated function outputs off after the loco comes to a stop.

See next page!

**An alternative method for directional functions:**

The directional bits (0,1) in CV #125 to 132 (special effects) allow a directional function to be split into two direction specific functions, if at the same time bits 2 – 7 are set to "0".

**Example:** In order to control both function output FO1 and FO2 with F1 and direction, proceed as follows:  
 CV #35 = 12 (bit 2 and 3 for FO1 and FO2 in CV #35),  
 CV #36 = 0 (recommended, otherwise 2 function keys would act on FO2 by default)  
 CV #127 = 1 ("Special Effect" variable for FO1, CV #127 "active in forward direction")  
 CV #128 = 2 ("Special Effect" variable for FO2, CV #127 "active in reverse direction").

**Or:** Output FO5 and FO6 operated with F5 key and directional control:

CV #39 = 24 (Bits 3, 4), CV #131 = 1 (forward), CV #132 = 2 (reverse).

The configuration variables CV #33 to #46 refer to the function keys (F...) of the cab; the single bits to the function outputs (FO...) of the loco decoder. The function keys are matched to the function outputs by setting the appropriate bits (indicated in the table below with ●). Multiple assignments are permissible.

„Mapping“ according to NMRA standards with default assignment shown as ●:

NMRA Function	CV	Number key on ZIMO cabs	Additional function outputs Usually available on large-scale decoders only, but shown here for the sake of completeness.							Function outputs; The number of available outputs depends on the decoder type. Always available are the outputs "Front light" and "Rear light".							
			FA12	FA11	FA10	FA9	FA8	FA7	FA6	FA5	FA4	FA3	FA2	FA1	Rear light	Front light	
F0	#33	1 (L) fw								7	6	5	4	3	2	1	0●
F0	#34	1 (L) re								7	6	5	4	3	2	1●	0
F1	#35	2								7	6	5	4	3	2●	1	0
F2	#36	3								7	6	5	4	3●	2	1	0
F3	#37	4				7	6	5	4	3	2	1●	0				
F4	#38	5				7	6	5	4	3	●	1	0				
F5	#39	6				7	6	5	4	3●	2	1	0				
F6	#40	7				7	6	5	4●	3	2	1	0				
F7	#41	8	7	6	5	4	3	2●	1	0							
F8	#42	<del>9</del>	7	6	5	4	3●	2	1	0							
F9	#43	<del>1</del>	7	6	5	4●	3	2	1	0							
F10	#44	<del>2</del>	7	6	5●	4	3	2	1	0							
F11	#45	<del>3</del>	7	6●	5	4	3	2	1	0							
F12	#46	<del>4</del>	7●	6	5	4	3	2	1	0							

~~9~~ = Shift-Key

The above table shows the default settings; that is, the function key numbers correspond to the same numbered outputs. Therefore the following values were written to the configuration variables:

CV # 33 = 1; CV # 34 = 2; CV # 35 = 4; CV # 36 = 8; CV # 37 = 2; CV # 38 = 4; and so on.

**EXAMPLE of changing CV's for individual assignments (●):**

F2	# 36	3							7	6	5●	4	3●	2	1	0
F3	# 37	4			7	6	5●	4	3	2	1	0				
F4	# 38	5			7	6●	5	4	3	2	1	0				

EXAMPLE above: The output #5 (FO5) should be switched in addition to output #3 (FO3) with the F2 key (ZIMO #3 key). Outputs #7 (FO7) and #8 (FO8) should be switched (not additionally but instead) with the F3 and F4 keys, which results in the above configuration (●).

The new values to be entered are as follows: CV36=40; #37=32; #38=64.

**Alternative function mapping without “left-shift”, for MX63 and MX64:**

**CV #61 = 97** overrides the higher CV’s “left shift” (from CV #37) of the NMRA function mapping (see previous page), which allows to map higher function keys with lower function outputs (e.g. It is not possible with NMRA function mapping to map F4 to FO1 but it is possible this way).

Therefore:			FA6	FA5	FA4	FA3	FA2	FA1	Rear	Front	Headlight
F0	#33	1 (L) fwd	7	6	5	4	3	2	1	0	●
F0	#34	1 (L) rev	7	6	5	4	3	2	1	●	0
F1	#35	2	7	6	5	4	3	2	●	1	0
F2	#36	3	7	6	5	4	3	●	2	1	0
F3	#37	4	7	6	5	●	4	3	2	1	0
F4	#38	5	7	6	●	5	4	3	2	1	0

and so on

and so on

**Modified NMRA function mapping for the MX620 and MX64D;**

(the MX620 and MX64D always use the function mapping in this manner but it is not possible with the MX63/MX64)

Because the **miniature MX620** and the 21-pin MX64D decoders have a maximum of 6 function outputs (headlights, FO1, FO2 and with the SUSI interface deactivated additionally the logic level outputs FO3 and FO4), the “left over” bits of the NMRA conforming registers from #37 are moved “to the front” and allow the lower numbered outputs (e.g. headlights) to be reached with higher numbered function keys (F3 to F12), which would be impossible with the NMRA function mapping.

**Therefore:** NMRA standard (dark grey fields) with “turned over” bits“ (light gray):

NMRA Function	CV	Number key on ZIMO cabs	MX620 or MX64D function outputs								
			FA5	FA4	FA3	FA2	FA1	Rear light	Front light		
F0	#33	1 (L) fwd									●
F0	#34	1 (L) rev									●
F1	#35	2									●
F2	#36	3									●
F3	#37	4									●
F4	#38	5									●
F5	#39	6									●
F6	#40	7									●
F7	#41	8									●
F8	#42	(D-) 9									●
F9	#43	D- 1									●
F10	#44	D- 2									●
F11	#45	D- 3									●
F12	#46	D- 4									●

**CV # 61 = ...** overrides the NMRA mapping and assigns the outputs to fixed function keys with the exception of F1 whose assignment remains flexible with CV #35.

A specialty of the “ZIMO special assignments” is the directional bit, which is available for function outputs.

**ZIMO – special function assignments for MX62, MX63, MX64**

NOT for MX620 or MX64D (see next page)!

with CV #61 = 3 or 4

Func	CV	Number key on ZIMO cabs									
			FA5	FA4	FA3	FA2	FA1	Rear light	Front light		
F0 forward		1									●
F0 reverse											●
F1	#35	2									
F2		3									
F3 forward		4									
F3 reverse											
F4		5									
F7		8									
Direction's Bit											

CV #61 = 3 or 4 Typical application: for directional taillights.

NOTE: for an alternative method, use “Effects”, see CV table!

**ZIMO – special function assignments for MX62, MX63, MX64**

NOT for MX620 or MX64D (see next page)!

with CV #61 = 5 or 6

Func	CV	Number key on ZIMO cabs									
			FA5	FA4	FA3	FA2	FA1	Rear light	Front light		
F0 forward		1									●
F0 reverse											●
F0 fwd. & F3 off											
F0 rev. & F3 off											
F1	#35	2									
F3 forward		4									
F3 reverse											
F4 forward											
F4 reverse		5									
Direction's Bit											

CV #61 = 5 typical application: directional taillights and cab light.

CV #61 = 6 typical application: Swiss electric and diesel engines.

## ZIMO – Special function mapping: Function mapping procedure with CV #61 = 98:

MX620, MX64D, MX64P only!

This procedure allows free allocation of function outputs to function keys (on the cab) that is not possible by setting fixed values in configuration variables.

To carry out this procedure requires a bit more time and attention from the user.

\* **Preparation:** The loco must be on the main track (not on the programming track); the whole procedure is performed with operations mode programming. Set the loco direction to “forward”, all functions off.

\* **CV #61 = 98** Writing value “98” to CV #61 (in operations mode) starts the actual allocation procedure.

The decoder is now in a special programming mode, which will not end until the whole programming procedure is completed or the loco is lifted from the track for a few seconds.

\* The decoder is now ready to accept the first function output allocation, starting with function output **F0 in forward direction**.

The function outputs (as many as desired) to be assigned to F0 in forward direction, are now actuated with the corresponding function keys (i.e. FLf, FLr, F1...F12).

Because only one function key (F0) is available for FLf and FLr (headlights), it is necessary to press F0 repeatedly to select the desired configuration (which alternately actuates the front and rear headlights).

The assignment must be confirmed by pressing the **direction’s key**.

\* The decoder is now ready to accept the next output assignment for **F0 but now for “reverse”**.

Continue as above!

Again, once a selection is made press the **direction’s key** to apply.

\* **Continue in the same fashion for all function keys** (28 function-direction-combinations)!

\* After the last function key (F12 “reverse”) has been assigned, the function outputs FLf and FLr (both headlights) are turned on to indicate the end of this programming procedure.

Confirm again by actuating **the direction key**.

\* After confirmation, the finished allocations are **automatically activated** and CV #61 is set to “99”.

### Deactivation:

CV # 61 = 0 ... 97 (any value except 98 and 99) deactivates the function assignment and again activates the function mapping according to CV #33 to #46 or CV #61, if a value between 1 and 7 is entered. The assignment defined during this procedure though remains stored in the decoder.

### Reactivating already stored data:

CV # 61 = 99 Reactivates the defined output allocations.

## Decoder MX620, MX62, MX63, MX64

### NOTES:

The special effects (US-lighting, uncoupler, soft-start etc) can also be assigned using above procedure. CV's #125, 126 etc. always refer to actual outputs!

It is possible to store and selectively re-activate several function output allocations with the help of the “CV-set” feature!

For a better understanding, the function keys or, more accurately, the function-direction-combinations are listed here in the sequence in which they are defined:

1. F0 forward
2. F0 reverse
3. F1 forward
4. F1 reverse
5. F2 forward
6. F2 reverse
7. F3 forward
8. F3 reverse
9. F4 forward
10. F4 reverse
11. F5 forward
12. F5 reverse
13. F6 forward
14. F6 reverse
15. F7 forward
16. F7 reverse
17. F8 forward
18. F8 reverse
19. F9 forward
20. F9 reverse
21. F10 forward
22. F10 reverse
23. F11 forward
24. F11 reverse
25. F12 forward
26. F12 reverse

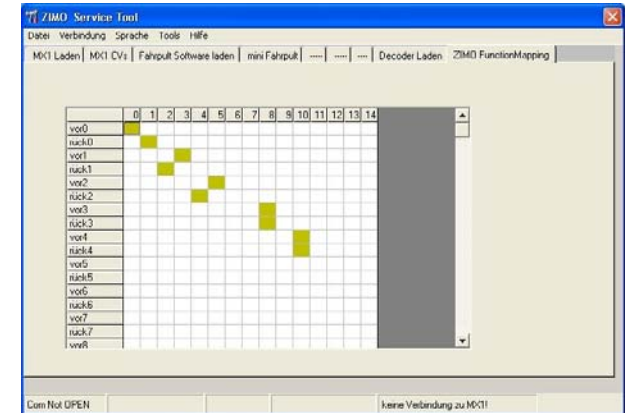

In the fall of 2007 an easy to work with tool that replaces the “CV #61 = 98” procedure will become available as part of the “ZIMO Service Tool “ZST”, where the desired functions can be “mapped” into a table and the procedure described above will be carried out automatically!

## 6. “Bi-directional communication”

The future oriented technology that has been installed (hardware) on all ZIMO decoders since 2004, can be activated since March 2007 with SW version 28 in the MX62, MX63 MX64, MX64H and MX64V, with SW version 4 in all MX620 and with the first SW version in the MX64D and MX64P decoder.

“Bidirectional” means that the information transfer within the DCC protocol is not only flowing towards the decoder but also in the opposite direction; that is not just driving, function and switch commands are being sent to decoders but also messages such as acknowledgements and status information are being received from decoders.

The definitions for RailCom are determined by the “RailCom working group” (Lenz, Kühn, Tams and ZIMO), before that by the NMRA RP’s 9.3.1 and 9.3.2 for bidirectional communication; with the goal of a uniform platform for “RailCom” applications.

The functionality is based on short cut-outs (max. 500 micro seconds) introduced to the otherwise continuously sent DCC signal by the command station. These cut-outs provide the opportunity and enough time for the decoders to send a few bytes of data to locally mounted detectors.

With the help of  = bidirectional communication, it will

*be possible that the decoder can acknowledge received commands*

which increases operational reliability and the bandwidth of the DCC system because already acknowledged commands don’t need to be sent repeatedly;

*“Global” information from decoders is sent to the command station*

e.g. “real” train speed, motor load, routing and position codes, “fuel reserves”, current CV values on demand from decoders to command station or more precisely, to a **global detector** in the command station, system cab MX31ZL and successors;

*Decoder addresses are recognized by “local” detectors:*

the actual loco positions are determined by local detectors connected to individual track sections (integrated in the MX9 track section modules or its successor the MX900). This however has been possible with ZIMO’s own loco number recognition for over a decade without bidirectional communication but only with ZIMO decoders.

Starting in 2007, RailCom will be further developed over the coming years and will bring new applications, which of course require new software updates in decoders and other equipment. In the first phase - March 2007, SW version 28 – ZIMO decoders will be able to send their own loco address from an isolated section of track (with a so called broadcast method, very fast, although only for one loco inside that section) with some decoder data such as actual speed, load and decoder temperature.

On the system side, a third party product is available from the beginning – the address display LRC120, which is a “local” RaiCom detector displaying the loco address of one track section. In the course of 2007, the MX31ZL will become available with an integrated “global” RailCom detector and finally “global” RailCom detectors for the installation into ZIMO command stations MX1EC, MX1, MX1HS as well as MX31 cabs.

The RailCom function is activated with CV #29, Bit 3 (see chapter 3, CV list and CV #28)

„RailCom“ is a trademark of Lenz Elektronik GmbH.

## 7. Installation and wiring

### General information:

There has to be enough **free space inside the engine** so that the decoder can freely be mounted. Pay particular attention that no pressure is exerted on the decoder when the loco housing is being reinstalled and the wires can’t get caught by movable parts.

All direct connections that are present in the original wiring configuration between the power pick-ups (wheels and wipers) and the motor **must be isolated**; otherwise the decoder end stage may get damaged at power-up.

The same goes for the **headlights and other additional accessories**, which must be completely isolated.

### *Do noise suppression components on a locomotive motor have a negative affect on motor regulation?*

**Yes, sometimes** . . . (in modern engines more so than on older ones)

Explanation: Motors of model railroad locomotives are often equipped with choke coils and capacitors, which are supposed to suppress or filter out noise (poor TV reception etc.) caused by the sparks arcing across the motor’s brushes.

Such components impair the motor regulation. Compared to others, ZIMO decoder manage quite well, that is there is hardly a difference in performance with or without those components in place. However, in recent years larger choke coils are being installed in many locomotives than was the case earlier – and these can noticeably compromise drivability.

The potentially “harmful” choke coils are often recognizable by their shape of a resistor with color bands (in contrast to a wire wound ferrite bar). That doesn’t mean though that these choke coils have a negative effect in all cases.

**Fleischmann locomotives** with “Round motors” often have **extremely bad filter components**; especially those capacitors that connect between the motor connections and the frame. These are often hard to see and to get at.

Indications of an actual negative effect of such components, besides a general unsatisfactory motor control (jerking...), are:

- weak control compensation: as a test, set the decoder to low frequency – CV #9 = 200 – and check to see whether the control compensation becomes stronger. If that’s the case, the choke coils are most likely to blame for the weak compensation in the high frequency range.

- if a difference in compensation is noticeable between 20 and 40 kHz (select in CV #112, Bit 5); if the compensation (further) diminishes at 40 kHz, it is very possible that the choke coils or capacitors are the cause.

Remedy: Bypass or remove choke coils! Capacitors are less likely to interfere with motor regulations but cannot be ruled out (see “Round motor” above).

### *Locomotives with 6 or 8 pin NMRA interface . . .*

. . . are easy to retrofit with the MX...R, MX...F, MX...N (e.g. MX63R or MX64F) etc. They come with the appropriate 8 (R) or 6 (F, N) pin connector. There is usually enough room provided in such locos, at least for the smaller MX62 or MX63 decoders. By removing the dummy plug from the loco, all damaging connections mentioned above should be interrupted and the decoder can be plugged in instead. This is unfortunately not

always true with some loco manufacturers. It is advisable to use an ohmmeter to confirm this before plugging in a decoder.

**Hard-wiring a locomotive...**

**... with a DC motor and headlights:**

This probably represents the **most common wiring diagram** for HO installations. All other diagrams that follow are modified or extended versions of this one.

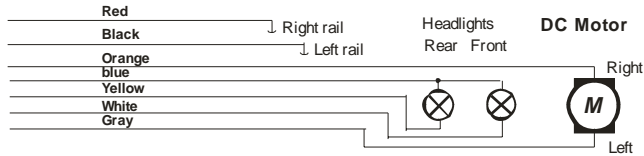

Lights connected as shown on this diagram are direction controlled and switched on/off by the F0 key (1 on Zimo cab). The lights can also be controlled independently with F0 and F1 for example (1 and 2 on Zimo cab), using function mapping CV's #33, 34, 35.

PLEASE NOTE: Body mounted light bulbs that are hard to insulate can be left as is. The body acts as the power supply to the bulb. The blue lead from the decoder must not be connected to the bulbs in such circumstances. The white and yellow leads are connected to the other side of the bulbs. The brightness of the headlights will be reduced in such an application

**... with an AC engine:**

Two additional 1N4007 diodes (or equivalent) are required as shown in the diagram below. They can be obtained at your local electronic store or from ZIMO.

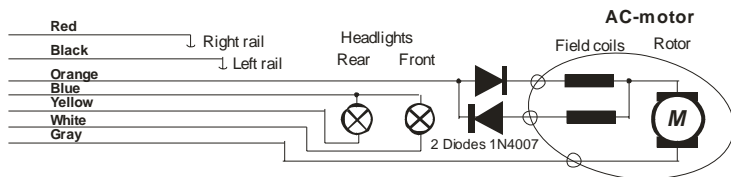

Most locomotives that run with an AC motor get the power supplied by a third rail, which doesn't change anything as far as the motor hook-up is concerned. The above schematic is therefore valid for AC locomotives running on two or three rail track.

Note: many locomotive manufacturers supply field magnets that can be used in place of the motor's field coil. Using a field magnet turns an AC motor into a DC motor, which is connected as such (see above) and can also utilize the decoders BEMF feature (BEMF does not work with AC motors).

**Cab lighting controlled with F0 key:**

This is no longer of much use today; it is a remainder from a time when decoders only had two function outputs, which were used for the headlights and the cab light. Cab lights connected this way can be switched with the F0 key but in contrast to the headlights were non-directional.

This is however a general schematic that can be used in cases where something is to be operated by several different function outputs, but the same outputs used independent of each other. There are 2 diodes required (type 1N4007 or equivalent) available from ZIMO or any electronic parts supply store.

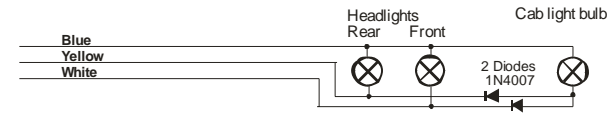

**Connecting function outputs FO1 and FO2:**

The MX620 has solder pads available for function outputs FO1 and FO2; other types have wires and can be connected in the same fashion as the headlight bulbs. The outputs can be used for different things such as cab lighting, smoke generator or uncouplers (also see relevant section below). For mapping the outputs to function keys, see chapter 5; the function outputs FO1 and FO2 are by default mapped with function keys F1 and F2.

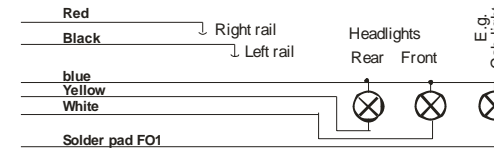

**Using logic level outputs:**

ZIMO decoders also have so called logic level outputs in addition to the normal function outputs, to which current consuming devices may not be connected directly. Use a M4000A amplifier board or similar transistor switching device, when connecting logic level outputs with a load.

In addition to the 4 normal outputs, the **MX620** offers the two connections "SUSI-CLOCK" and SUSI-DATA" as logic level outputs FO3 and FO4 by setting CV #124 Bit 7 = 1 (if SUSI is not required); see CV #124 in the CV table and function mapping in chapter 5!

This is similar with **MX63** and **MX64** decoders but for logic level outputs FO5 and FO6, alternative to "SUSI-CLOCK" and SUSI-DATA".

An **amplifier module M4000Z** is connected with its brown lead with the relevant logic level output solder pad of the decoder.

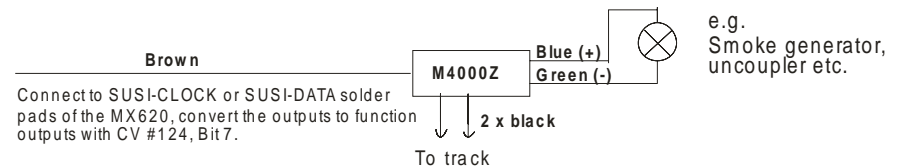

**Connecting DIETZ sound modules / virtual cam sensor**

See Dietz instruction manual (MX65/MX66 decoder instructions may also be helpful). For sound boards with SUSI, see below!

For a good acoustic impression of steam engines, it is important that the chuffs are synchronized to wheel revolutions. Therefore a cam sensor should be installed and connected to the sound module (reed switch, optical or hall-effect sensor), which sends exactly 2 or 4 pulses to the module (depending on loco type).

Sound modules can usually generate their own chuff rate based on speed information (e.g. coming from the SUSI interface of a decoder), if no cam sensor can be installed or installation proves too difficult. The result is often poor with a chuff rate that is too fast at low speeds (the SUSI protocol is not precise enough in that respect).

To improve this situation, ZIMO decoders come with a “virtual cam sensor”. The MX620 uses the function output FO2 for this, which is converted for the “virtual cam sensor” function with the help of CV #133 and connected with the cam sensor input of the sound module (e.g. Dietz, reed switch input); naturally in addition to SUSI or other connections.

The virtual cam sensor is of course not capable of synchronizing chuff rates to wheel positions but rather to wheel speed, which makes little difference to the viewer.

The chuff rate of the “virtual cam sensor” can be defined per wheel revolution with CV #133; consult CV table in chapter 3.

**The “SUSI” interface:**

The SUSI interface developed by Dietz is an NMRA standard and defines the connection between sound modules and loco decoders, provided the sound module is also equipped with such an interface. Due to space restrictions on small decoder, the SUSI interface composed of 4 conductors (2 data, ground and power) is not built as a plug-in connector but instead uses **4 solder pads**. The larger MX64H and MX64V do come with **SUSI connectors!**

Speed and load information (e.g. to change sound intensity when going uphill, downhill, start up etc.), as well as sound-configuration variables (CV’s #890...) are sent by SUSI from the decoder to the sound module.

**Accessing SUSI CV’s:** These CV’s are in the 890 range, according to the standard (NMRA DCC Draft RP), which is not accessible with many DCC systems (ZIMO cabs MX2 and MX21 were also limited to 255 - until mid 2004). For this reason, ZIMO decoders allow access to these CV’s with numbers in the 190’s!

**Connecting an electric uncoupler (System “Krois”):**

In order to prevent damage to the delicate core of an uncoupler from continuous power, appropriate adjustments can be made with special CV’s for one or several function outputs.

First, write the value “48” to the CV that is assigned to the same output the uncoupler is connected to (e.g. CV #127 for output #1, CV #128 for output #2 etc.)

Next define the uncoupler activation time limit in CV #115 (see CV-table):

With the “Krois uncouplers”, it is recommended to use a value of “60”, “70” or “80” for CV #115; this means that the pull-in voltage (full track voltage) is limited to 2, 3 or 4 seconds. A reduced “hold” voltage is not required for Krois, that’s why the ones digit is left at 0. Other uncouplers may need a reduced hold voltage though, like the ones from ROCO for example.

Regarding the “automated coupler detachment”, see CV #116, chapter 4.

**MX620R, MX63R, MX64R with NMRA 8-pin interface (NEM 652):**

The “R” designated decoders’ come with an 8-pin plug mounted to the end of its wires, which fits in to the socket of a DCC ready loco. Remove

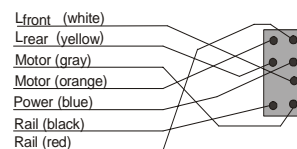

the dummy connector from the socket and plug the decoder in its place, that’s all.

All the necessary connections to power, motor and headlights are established with this interface. Other outputs have to be hard wired.

**MX620F, MX63F, MX64F with NMRA 6-pin interface (NEM 651):**

The “F” designated decoders’ come with a 6-pin plug mounted to the end of its wires, which fits into the socket of a DCC ready loco.

The brightness of the headlight is reduced since the blue wire (common supply) is not part of this interface. The light bulbs get their power direct from the power pick up.

The blue wire is still available at the decoder and can be connected to the bulb if more light is needed. The power supply from the track to the bulb needs to be cut first, of course!

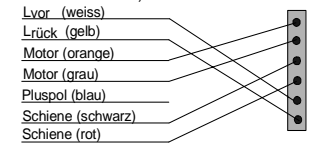

**MX620N plugs directly into the 6-pin interface (NEM 651):**

Many N, HOe, HOm as well as some HO engines have this socket installed with the required minimum space of 14 x 9 mm to accept the decoder.

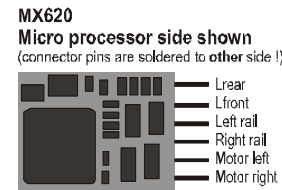

**ATTENTION:** Plug the decoder into the socket with the pins down and the micro processor visible!



**MX64D, MX64DV – Decoders with 21-pin interface:**

These decoders have a 21-pin female plug on the circuit board (no wires), which allows the decoder to be plugged directly in to the 21-pin male receptacle of locomotives equipped with such interfaces. There are actually 22 pins present but one of those (#11, top right) pins serves as a key to prevent wrong installations.

The meaning of the individual pins is usually not important to the user. The pins marked “n.c” are not used, they are reserved for special applications (Hall-effect sensors).

**MX64DV Top View**  
(= with the 21-pin connector side !)

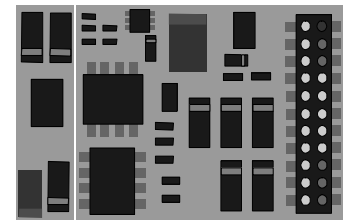

- |                          |                     |
|--------------------------|---------------------|
| Left row                 | Right row           |
| + 5 V (20 mA max)        | Key pin             |
| Function output FO3      | n.c.                |
| Function output FO2      | n.c.                |
| Function output FO1      | Front headlight     |
| <b>Low Voltage 1,5 V</b> | Rear headlight      |
| <b>Low Voltage 1,5 V</b> | SUSI Data           |
| Motor connection 1       | SUSI Clock          |
| Motor connection 2       | Function output FO4 |
| GROUND                   | n.c.                |
| Left rail                | n.c.                |
| Right rail               | n.c.                |

The MX64D can be **plugged-in two ways**; the board below the connector is perforated, so that **depending on the locomotive**, the decoder can be plugged in from the top or bottom end. **The key pin 11 prevents a wrong installation by not allowing the decoder to be pushed all the way down. This and/or the decoder not sitting level on the board indicate a wrong installment!**

**MX64D plugged into TRIX loco board**

MX64D plugged in right side up, Pins of the loco board penetrate through the decoder board into the socket.



**MX64D plugged into BRAWA loco board**

MX64D is plugged in upside down !



The **MX64DV** is largely identical to the MX64D but with the added hardware on the extended circuit board, it is capable of supplying low voltage for bulbs or other equipment. For more information go to the section „MX64V1, MX64V5, MX64DV“ in this chapter of the manual!

**MX620, MX64D, MX64DV5 – Connecting servo and smart servo motors:**

2 servo control outputs are available at the MX620 and MX64D (solder pads or part of the 21-pin socket) for the control of commercially available servo motors or SmartServo RC-1 (Manufactured by TOKO Corp. Japan). Each output can be connected directly with a servo input.

The model **MX64DV5** also supplies the servo with 5V operating voltage.

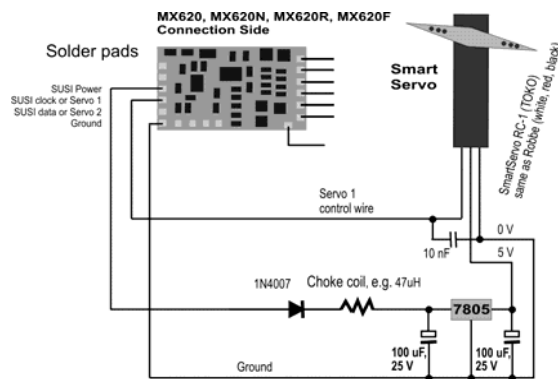

For the MX620 or MX64D (not the MX64DV5), the 5V operating voltage must be supplied by an external voltage regulator such as the readily available LM7805 as shown in the drawing.

NOTE: ZIMO plans to introduce its own brand of a 5V regulator. Compared to the LM7805, it will be easier to install and produce less heat!

The outputs can be activated for servo control duty with CV's #181 and CV #182 (the value in each must be different than 0).

With the help of CV #181 and #182, the servo functions can be mapped to various function keys (and direction) and selected for control with either one or two function keys. CV's #161 to #169 define the servos end positions and rotating speed, see CV table.

The servo outputs use the same connections as the SUSI CLOCK and DATA lines. It is therefore not possible to use the SUSI interface as long as the outputs are configured for servo control.

CV #161 is also used to select the appropriate protocol. "Normal" for most servos are positive pulses (which is also the default setting); furthermore a selection can be made whether the servo is powered only while it is being moved or remains powered at all times. The latter should only be used if the servo position can be changed by mechanical influences.

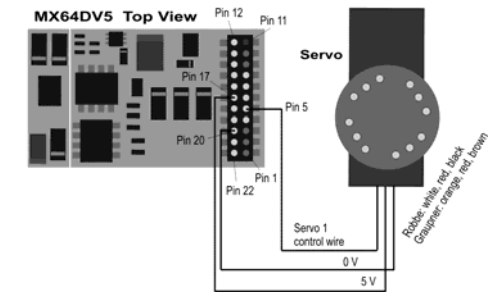
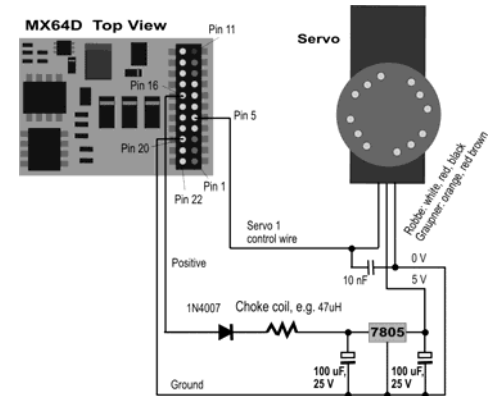

**Connection and control of an external energy source (capacitor) for uninterrupted driving on dead track sections:**

- With the help of an electrolytic capacitor or a battery the
- driving performance on dirty track sections (or wheels) can be improved
- flickering of lights is reduced
- and stalling of trains, especially when crawling, can be eliminated

The energy storage increases with the capacity of a condenser and from 100uF (Microfarad) onwards an effect will be noticed. 1000uF to 10'000uF are recommended if the necessary space is available. The required voltage strength of the capacitor is given by the track voltage; 25V is suitable for all cases. Smaller 16V capacitors should only be used if track voltage will never be higher than that.

The capacitor is connected between ground (available on all ZIMO decoders as solder pad) and power (blue wire or SUSI-POWER) of the decoder. Note polarity!

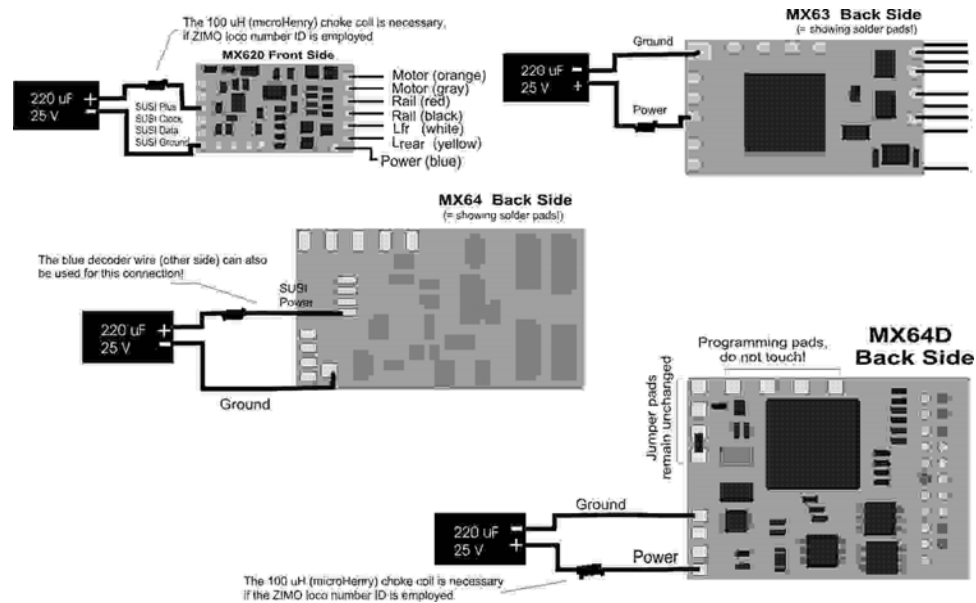

When using a 220uF or possibly a 470uF capacitor no other parts are really required for "simple" loco control; although installing a **choke coil (100 mH / 100 mA, available from ZIMO)** is recommended in the positive wire to guarantee that the decoder can be updated with the update module MXDECUP and that the ZIMO loco number identification works.

If larger capacitors are used, which is actually a good idea, extra circuitry is required. The condenser is recharged through the 100 ohm resistor. This is to prevent a shut down of the command station during start-up. If a large number of loco's so equipped are on the layout the command station could interpret the current flow to these capacitors as a short circuit. The diode (e.g. 1N4007) is required to bypass the resistor when power is needed by the decoder.

NOTE: If signal stops by "asymmetrical DCC signal" (= Lenz ABC, implemented in ZIMO decoders early 2005) is employed, the resistor-diode combination is necessary in any case (even when using small capacitors) to ensure that the decoder can detect the asymmetry of the signal!

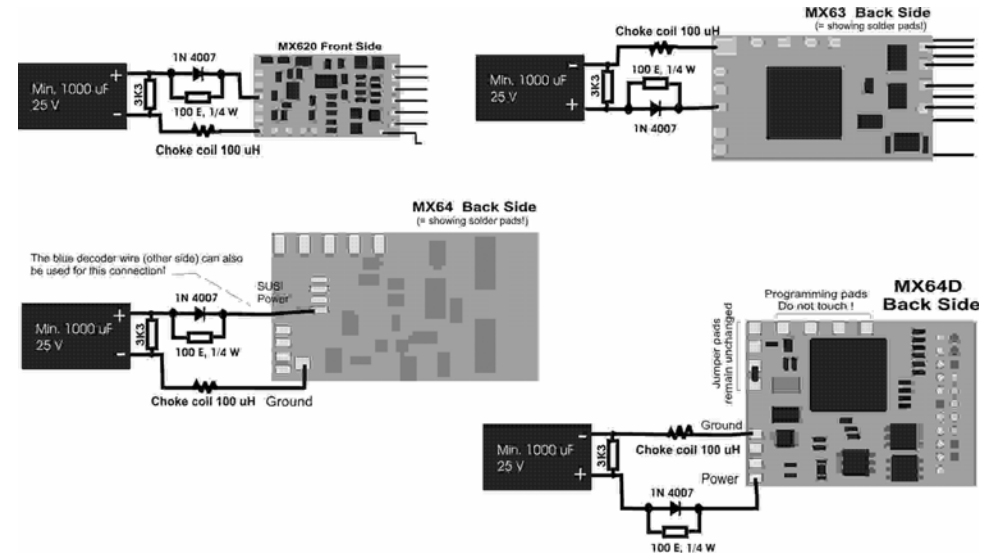

The purpose of the resistor 3K3 shown in the drawing above (not required in all cases) is: even though a large condenser supplies the motor and lights for just a few tenths of a second (1000uF) or a few seconds (e.g. 4700uF) the remaining power, although at a voltage level below what is required by the motor and lights, is sufficient power to keep the decoders memory alive for quite some time (several minutes). This is sometimes a rather undesired effect. For example: If a running loco is taken from the track and the speed then set to zero, the loco would briefly run at the previous speed when it is set back on the track after about a minute. Using the above-mentioned resistor would erase the memory after just a few seconds.

ZIMO offers a collection of components under the term (order number) **SPEIKOMP** that are required for building a do-it-yourself energy module to be connected to ZIMO decoders MX620, MX63 and MX64. The set contains a diode, resistors, choke coil and a few capacitors (you can and should use larger capacitors if space is available). A complete energy module (MXSPEIK) with above circuitry will be available from ZIMO in the course of 2008!

**Smart stop management on "dead" track sections**

In cases where power to the decoder is interrupted due to dirty rails, wheels or insulated frogs, the decoder automatically keeps the engine going even though a currently active brake application should bring the train to a stop. Only when power to the decoder is restored is the loco allowed to stop, with subsequent testing to ensure power to the decoder is still available after the engine stopped (if not, the engine is moved again a short distance).

**MX64V1, MX64V5, MX64DV1, MX64DV5 - The special MX64 or MX64D design with built-in low voltage supply**

The **MX64V1** contains an efficient **1.2V voltage regulator**, which can be directly connected to low voltage bulbs. This facilitates the decoder installation considerably especially in high quality brass models (which are often equipped with such bulbs), because it eliminates the installation of an external voltage regulator (that often requires some sort of heat dissipation).

The **MX64V5** is a variant of the MX64V1 with a **5V regulator**, mostly for installations in large scale such as O-scale or higher (LGB), where 5V bulbs are often found.

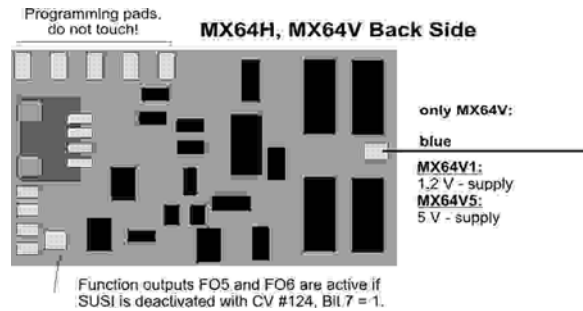

Otherwise, the MX64V1 and MX64V5 are identical to the MX64H (1.8A, SUSI connector etc.)!

NOTE: The above voltage supply is to be preferred over the dimming function in CV #60. The dimming function works with PWM at full voltage that can damage bulbs. An even higher risk is taken during programming on the programming track with the accompanying acknowledgement pulses.

The **MX64DV1** or **MX64DV5** comes on a longer circuit board than the MX64D and contains a **1.5 V or 5.0V regulator** for low voltage light bulbs. As delivered, the low voltage is available at the common positive pins 16 and 17; meant for locomotives that use low voltage bulbs only. The usual full track voltage is not available.

**MX64DV Front Side**  
(= showing the 21-pin socket!)

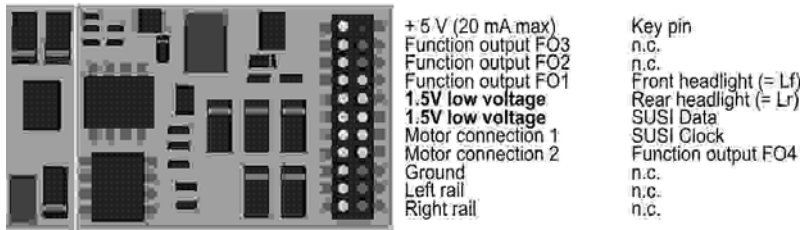

Full track voltage is provided on pin 16 after rearranging a jumper wire. This is practical for applications that require full track voltage as well as low voltage.

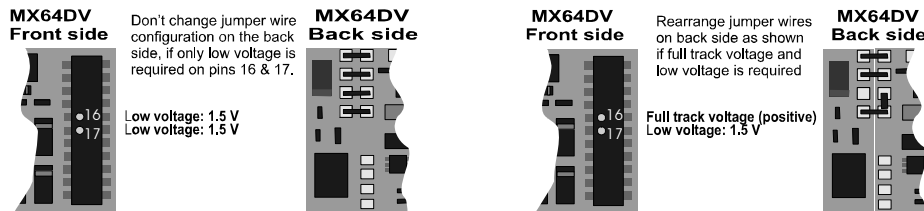

**8. MX64D, MX64DM for C-Sinus / SoftDrive-Sinus**

The MX64D and MX64DM can be switched to a **matching output configuration** required for the control of the **C-Sinus boards** found in many Märklin and Trix locomotives with **C-Sinus motors**, provided the locomotive comes with a 21-pin interface. The decoder also **supplies** the necessary **5V** the C-Sinus board needs to operate (which „normal“ decoders are not capable of!).

The MX64D (or MX64DM) is plugged into the pins of the loco board with the top side of the decoder pointing up, whereby the pins are being pushed through the decoder board in order to make contact with the decoder socket. The position is given by the loco board and is also keyed by the missing pin 11 (on the loco board) and missing hole in the same location on the decoder board.

The picture below shows a sample layout; the loco board may however vary from case to case.

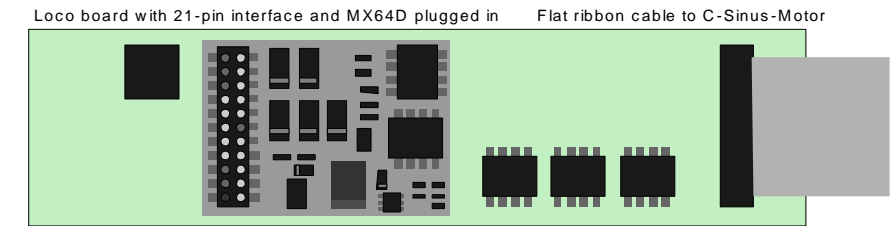

The switch-over to the C-Sinus control takes place with CV #112, Bit 0 = 1. Because the acknowledgement method doesn't work in most cases during service mode programming when the decoder communicates with the C-Sinus board, Bit 1 of CV #112 must also be set in order to utilize the special „internal high frequency shorts“ as acknowledgement pulses. That means for most cases

**CV #112 = 3 or CV # 112 =7** (with loco number ID pulses for ZIMO applications)

Special configurations are possible with **CV #145**, which is necessary because of the different interfaces used by Märklin/Trix, see CV table!

An MX64D equipped C-Sinus locomotive can be operated in the **NMRA-DCC-data format** as well as the **MOTOROLA protocol** but not in analog mode (DC)!

No motor regulation, known as BEMF, takes place when the decoder operates in the C-Sinus mode, since the motor tries to keep the target speed precisely in all situations. The relevant configuration variables, among them CV #9, #56 and #58, are without effect!

The **MX64DM** is a special development for locomotives with **SoftDrive-Sinus** and some locomotives with **C-Sinus motors** (which won't operate with the MX64D). It differs from the MX64D in that the function outputs FO3 and FO4 (= AUX3, AUX4 according to NMRA interface specifications) are designed as logic level outputs and are capable of supplying the 5V required for powering up the Softdrive loco board (also required by some C-Sinus boards).

**CAUTION:**

Unfortunately, Märklin/Trix has played a "dirty trick" (although probably not on purpose): Beginning with a specific model or past a certain date, the protective resistors on the loco board input have been omitted, or more precisely, instead of the 100kΩ resistors useless 0 Ohm resistors are being installed. As a result, a high voltage from the MX64D or MX64DM reaches the loco board that will not only destroy the board but can

also damage the decoder; unless the decoder has been set first to the C-Sinus (Softdrive-Sinus) mode with CV #112 = 7.

But even if CV #112 = 7 is set, there is no guarantee that the loco board will survive (even though there is no visible problem)!

Background information: Although the 21-pin interface in Märklin and Trix locomotives is virtually identical to the standardized NMRA-DCC 21-pin interface, Märklin keeps modifying it whenever the need arises (several versions, misapplication of function outputs for motor activation and now the mentioned electrical input changes); their own brand decoder is the only one that is being taken into account through all this. The installation of other brand decoders is, to be sure, undesired...

**CORRECTIVE MEASURE:** The **MX64D / MX64DM must not** be installed if zero-ohm resistors (markings "000") are found on the loco board instead of functional protective resistors ("104"). It is imperative that these are being replaced with **100KO resistors ("104")** before installing the decoder. ZIMO MX64DM decoders will be delivered with the necessary resistors.

Below is a picture showing a loco board with the useless ("000") resistors; in such cases it is not allowed to plug in a MX64D / MX64DM decoder!

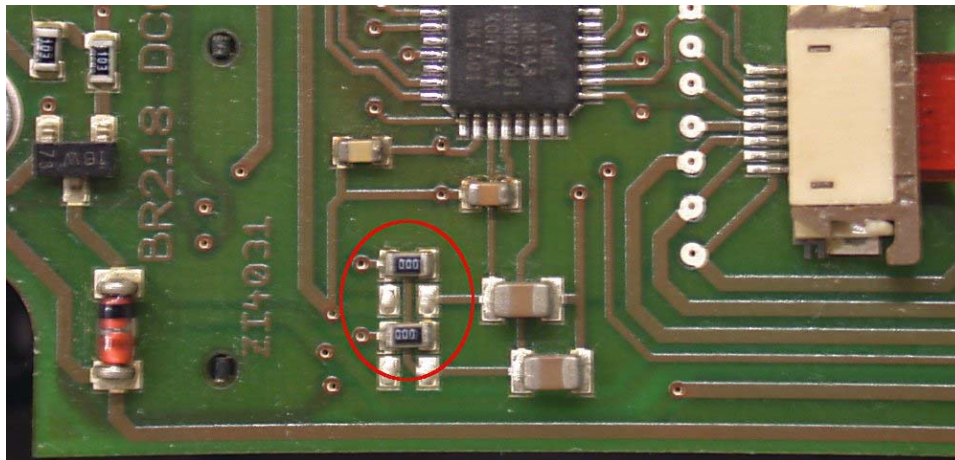

Due to the many different C-Sinus boards that have been produced it is impossible for us to provide precise information about the location of these resistors on each board. Because the resistors may be mounted in different locations on the board in your engine, we would suggest that you find them by following the tracers. First study the picture below. The blue and pink arrows are pointing out the tracers that connect these resistors with the processor. Note the processor pins those tracers are leading to.

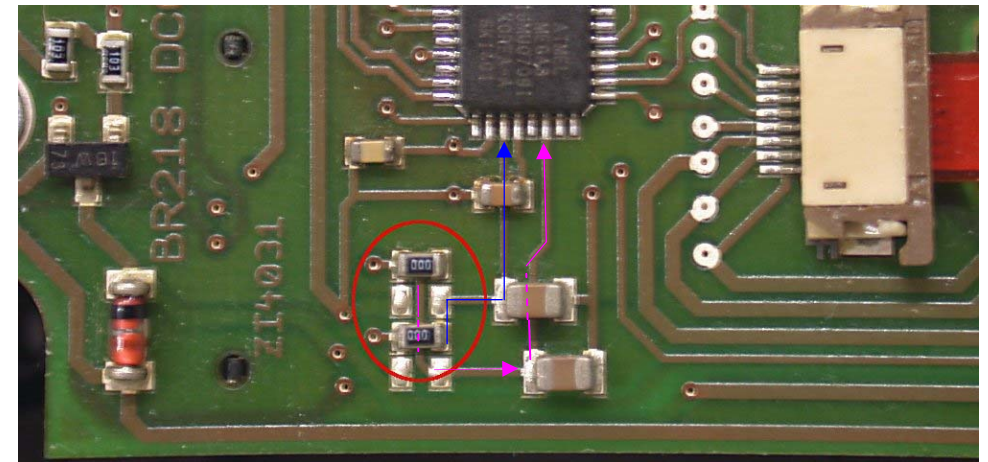

Next find the same pins on the processor of your board and follow those tracers carefully. They should lead to resistors marked as either "104" or as "000" (see below). If they are "104" proceed with the decoder installation. If they are marked as "000" they have to be replaced before the decoder is installed.

**In any case, due to the numerous and undocumented changes of these boards, ZIMO cannot assume liability for damage to loco boards and/or decoders.**

This picture shows a different Märklin C-Sinus board and how the resistors in question can be located by following the tracers back from the controller pins.

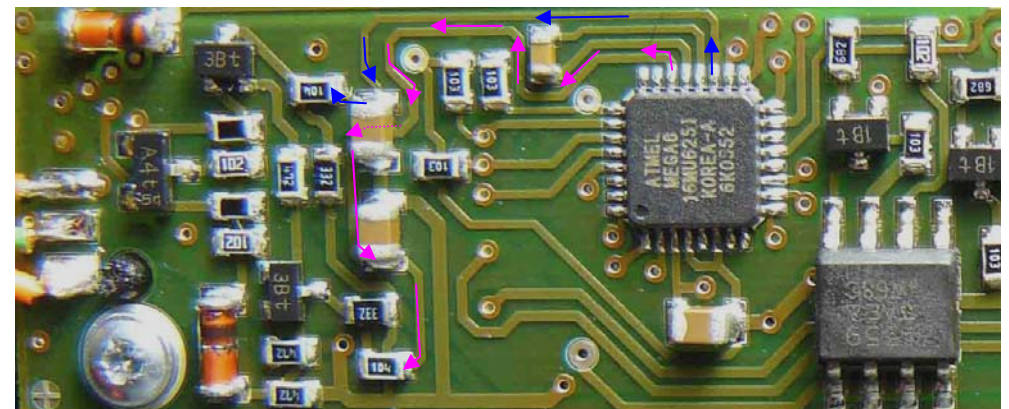

## 9. ZIMO decoders and competitor systems

All Zimo decoders comply with NMRA standards and recommended practices and can be used on layouts with other brands of NMRA compliant systems.

What most systems of other manufacturers have in common, in contrast to ZIMO systems, is that track power is not stabilized or only partly stabilized and often relatively weak (in regards to voltage but also amperage). This can lead to uneven speeds and/or limited top speed because Zimo decoders are of course programmed by default to operate on stabilized and regulated track power of up to 24V from a Zimo command station.

It is recommended if required to:

- change **CV #57** (reference voltage) from "0" (where regulation is based on track voltage) to a fixed voltage. For example: "140" for a DCC system with a typical track voltage of 16 - 18V. In this case 14V will be used as reference, which leaves a certain safety margin during voltage drops.

Note that the MX62 always uses a fixed voltage.

### ... with Lenz "DIGITAL plus" from software version 2.0

This system uses 28 speed steps beginning with version 2.0 and 128 steps with version 3.0 and up. It also programs in direct mode according to NMRA DCC standards and is therefore fully compatible with Zimo decoders.

All Zimo decoders are set to 28 speed steps by default. Make sure the system is also set to 28 steps for the decoder address in question. Incompatibility will be the result if the speed steps between decoder and system do not agree with each other; which is most often noticed by non working headlights. It would only make sense to switch the system from 14 steps to 28 or 128 speed steps rather than setting the decoder back to 14 steps, which would result in unnecessary poor drivability.

All configuration variables are accessible; see the manual for the cab in question. The address is located in the registry's position #1.

The configuration variables #49 to #54 will have no effect, since the signal controlled speed influence is only supported by a Zimo system.

### ... with ROCO Lokmouse-2

Although the Lokmaus-2 allows CV programming, its display is limited to two digits only and therefore limits the number of CV's and their values to 99.

Zimo decoders offer a special pseudo-programming feature with CV #7 (that normally stores the software version number) to allow unrestricted programming. It is called pseudo-programming because the permanently stored value in CV #7 cannot be overwritten but rather holds a temporary value that allows the Lokmouse2 to be used for expanded programming capabilities (see CV table); the engine must not be running during the programming procedure!

Example:

To enter a value of 160 (which is not possible with a Lokmouse-2 because value is >99) to CV #5 (max. speed) proceed as follows:

First program CV #7 to 1, followed immediately by setting CV #5 to 60. No power interruptions between those steps are allowed.

## Decoder MX620, MX62, MX63, MX64

Explanation: The value 1 in CV #7 actually 01 (tens digit=0 and ones digit=1) causes the decoder to add 100 to the CV **value** that will be entered in the next programming step. Therefore, a value of 60 entered to CV #5 with the Lokmouse2 is stored as 160!

Example:

To program CV #122 (exponential deceleration), for example, with a value of 25 do the following:

Again, go to CV #7 and enter a value of 10, then go to CV #22 and enter a value of 25.

Explanation: CV #7 = 10. The 1 in the tens digit causes the decoder to add 100 to the CV **address** in the following programming step. As a result, CV #122 will be programmed instead of CV #22!

### ... with DIGITRAX Chief

No problems expected with this system!

The Digitrax system usually operates at 28 or 128 speed steps. If for some reason the headlights don't work, confirm that indeed the system and the decoder are set to the same number of speed steps and if necessary, change the speed steps at your cab to 28 or 128 steps.

There have been some malfunctions in the past during system boot up. For example: locomotives would not start unless the power to the decoder was interrupted briefly (by tipping the locomotive off one rail). It is not quite clear whether the causes have ever been fully identified and eliminated; it may also depend on the command station model (year of manufacture) and the software version in the Digitrax command station.

### ... with UHLENBROCK Intellibox

Operation, addressing and programming are possible without limitations!

Normally the speed step mode of the Intellibox and the ZIMO decoder are a match (by default in both cases 28 or 128 speed steps, which is fine either way). If the headlights don't work even though the decoder is wired properly, make sure the decoder address is not set to 14 speed steps – this would need to be corrected on the cab to 28 or 128 speed steps.

## 10. Special - CV - Sets

At this time (July 2008) only available in MX62, MX63 and MX64!!

This feature allows easy programming of a group of predefined values to the decoder's appropriate configuration variables. Such "CV sets" may be part of the decoder software at delivery (as listed and described in the table below) or defined by the user.

Typical applications are: Railroad specific lighting, motor specific data for perfect slow speed behavior, prototypical loco specific acceleration, easy switching between a passenger and goods train or single loco versus consist.

Programming of such CV-sets (either supplied or self defined) is accomplished by a **pseudo-programming sequence of CV #8 in Service Mode programming on the programming track** (CV #8 contains "145", the manufacturer code for ZIMO and cannot really be overwritten, therefore the term pseudo-programming).

The current practical application (from SW 11, further extended with SW 32, 34...) is:

**CV #8 = 31, 32, 33, 47 & 48.** These special CV-set were introduced as original equipment for a series of Dutch and Norwegian locomotives and defines the lighting as well as the speed and acceleration characteristics of those engines.

"Dutch Defaults" with CV set "31" (from SW version 32 in MX62, MX63 & MX64):

CV #2 = 1 / #3 = 6 / #4 = 4 / #56 = 183 / #58 = 250 /  
#63 = 70 / #121 = 35 / #122 = 15 / #124 = 24 / #127 = 4

Start voltage / Acceleration / Deceleration / PID-Regulation / BEMF setting /  
Mars light settings / Exp. Accel. / Exp. Decel. / Shunting key / Mars Light on FO1

"Dutch Defaults" with CV set "32" (from SW version 34 in MX62, MX63 & MX64):

CV #3 = 6 / #4 = 6 / #29 = 6 / #127 = 20

Acceleration / Deceleration / Config. (RailCom off) / Double pulse at FO1

"Dutch Defaults" with CV set "33" (from SW version 34 in MX62, MX63 & MX64):

CV #3 = 6 / #4 = 6 / #13 = 195 / #29 = 6 / #127 = 20

Acceleration / Deceleration / DC function / Config. (RailCom off) / Double pulse on FO1

"Norwegian Defaults with CV set "47":

CV #2 = 1 / #3 = 16 / #4 = 13 / #5 = 240 / #6 = 120 /  
#13 = 204 / #35 = 12 / #60 = 240 / #61 = 5 / #121 = 12 / #122 = 10 / #124 = 151

Start voltage / Acceleration / Deceleration / Maximum speed / Medium speed /  
Analog functions / function map F1 / Dimming / ZIMO function map / Exp. Accel. / Exp. Decel. / Shunting key

"Norwegian Defaults with CV set "48":

CV #2 = 1 / #3 = 16 / #4 = 13 / #5 = 240 / #6 = 120 /  
#13 = 204 / #35 = 48 / #60 = 240 / #61 = 5 / #121 = 12 / #122 = 10 / #124 = 151

Start voltage / Acceleration / Deceleration / Maximum speed / Medium speed /  
Analog functions / function map F1 / Dimming / ZIMO function map / Exp. Accel. / Exp. Decel. / Shunting key

More such sets and the possibilities for self-definition are planned for a future software version.

CV #8 = 8 as hard reset is of course still available as before. This will reset all configuration variables to default values according to the CV-table in chapter 3.

On the other hand, the hard reset procedure initiated by programming the decoder to address 0 with a ZIMO cab (MX2, MX21, MX31,...) will reset the decoder to the last defined special CV set. The Norwegian loco, in the above example, will remain just that.

## 11. Converting binary to decimal

If, according to the CV table, a CV calls for setting individual bits (which is the case with CV #29, 112 and 124, for example) proceed as follows:

Each bit has a specific value:

Bit 0 = 1  
Bit 1 = 2  
Bit 2 = 4  
Bit 3 = 8  
Bit 4 = 16  
Bit 5 = 32  
Bit 6 = 64  
Bit 7 = 128

The decimal values of all bits of a CV that are supposed to be set are added up (Bit... = 1 in the CV- table). All other bits (Bit... = 0) are ignored. Note that bits are numbered from right to left.

Example:

Bit 0, 2, 4 and 5 are supposed to be set (Bit...=1); but not the others 1, 3, 6 and 7 (Bit...=0).

This results in a bit-set of 00110101 and a decimal value of:

Bit 7 Bit 6 Bit 5 Bit 4 Bit 3 Bit 2 Bit 1 Bit 0

0 0 1 1 0 1 0 1

0 + 0 + 32 + 16 + 0 + 4 + 0 + 1 = 53 (decimal value)

The calculation in reverse:

A trial and error method is used to determine individual bits from a decimal figure: start with the largest value. If a number is larger or equal to 128 then Bit 7 = 1. If the remaining number is larger or equal to 64 then Bit 6 = 1 and so on.

Example:

The decimal figure of 53 is neither larger or equal to 128, nor larger/equal to 64 but is larger than 32. Therefore Bit 7 = 0, Bit 6 = 0 but Bit 5 = 1; the rest of 21 (53 - 32 = 21) is larger than 16 (Bit 4 = 1), the remaining 5 (21 - 16 = 5) is not larger than 8 but is larger than 4 (Bit 3 = 0, Bit 2 = 1), and finally 1 (5 - 4 = 1) is not larger/equal to 2 but is equal to 1 (Bit 1 = 0, Bit 0 = 1).

## 12. Operating with Märklin MOTOROLA systems

**At present (July 2007): MOTOROLA mode only for MX620, MX64D and MX64DV (not for MX63/MX64)!**

Using the MX620 in MOTOROLA mode only makes sense if the system used is not capable of operating in the DCC format. DCC is substantially more powerful and should to be the preferred protocol with a multi-protocol system.

The MOTOROLA data format is recognized automatically by the decoder.

**Addressing and CV programming** is possible with a Märklin system, albeit very tedious (because this system doesn't provide much help):

### TEMPORARY INSTRUCTIONS:

*Programming CV's with Märklin 6021 central unit:*

*Start the programming mode by:*

1. selecting the address of the engine to be programmed
2. press the "STOP" key at the central unit and wait a few seconds
3. Crank the speed regulator past the left stop and hold (direction switch)
4. press the "START" key
5. release the speed regulator

*The front headlight of the engine should now be flashing once per second indicating that the decoder is in the programming mode.*

*You can now choose between two programming modes:*

1. *Short mode: programming is limited to CV's 1 – 79 and a value range from 0 – 79*
2. *Long mode: the values to be used in each case are split and transmitted in two steps (CV 1-799, value range 0-255)*

*The short mode is always active after entering the programming mode.*

*To change to the long mode write 80 to CV #80 (enter address 80 and change direction twice to change to the long mode).*

#### **Short mode:**

*Enter the CV to be programmed in the central unit as an address and briefly operate the direction switch.*

*The headlight now quickly flashes twice.*

*Now enter the desired value to the selected CV and again operate the direction switch briefly (enter 80 for a value of 0).*

*The headlight flashes once indicating that you can program the next CV or end the programming by turning power to the track off.*

#### **Long mode:**

*Remember to set address 80 to a value of 0!*

*Enter the hundreds and tens digit in the central unit of the CV you want to program (for example: for CV 123 enter 12) and operate the direction switch.*

*The headlight now quickly flashes twice.*

*Now enter the ones digit of the same CV (for example: for CV 123 enter 03) and operate the direction switch again.*

*The headlight briefly flashes 3 times.*

*Enter the hundreds and tens digit in the central unit of the value you want to program and operate the direction switch.*

*The headlight briefly flashes 4 times.*

*Now enter the ones digit of the value and operate the direction switch again.*

*Again, the headlight flashes once indicating that you can program the next CV or end the programming by turning power to the track off.*

### 13. Software Update with MXDECUP

All MX62, MX620, MX63, MX64, MX64H, MX69, MX690, MX82 as well as all future ZIMO decoders can be updated with new firmware by the end user with the help of the update module MXDECUP or MXDECUPU (with USB converter).

New software versions can be downloaded at no charge from ZIMO's web site: [www.zimo.at](http://www.zimo.at) (under "UPDATE") and add new features, improvements and corrections to the decoder. The ZIMO Service Tool (ZST from version 1.4) is also required for the update procedure. This software can also be downloaded at no charge from [www.zimo.at](http://www.zimo.at).

Note that the decoder update page of the current ZST program (Version 1.7.1) is still in German. Until a new ZST version is released, a program extension can be downloaded with this page translated to English. Please download both, the original ZST mentioned above and the ZST extension from [www.zimo.at](http://www.zimo.at). Once both are installed on your PC, the extension can be started as a stand-alone program for decoder updates.

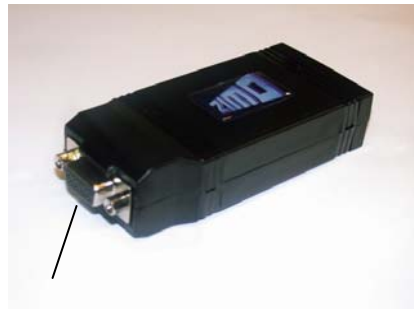

RS-232 – SUBD-9-socket

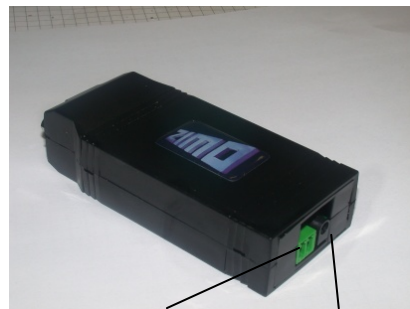

Connect to "update track", control-LED's behind socket  
connect to power supply

The update module comes with a power supply, an RS-232 connecting cable and a USB converter (in case of MXDECUPU). Power supplies (12V DC, 300mA minimum, unregulated), serial cable with two 9-pin sub-D connectors (1:1) and commercially available USB converters (USB to serial) can also be acquired locally if necessary.

#### Implementation and operation:

A **section of track** is used as "update track" and connected to the 2-pin screw terminal of the MXDECUP. Set the engine with the decoder that is to be updated on the track. The decoder can of course be connected with its red and black wires directly to the track connector of the module instead.

In contrast to the CV-programming procedure, the update procedure with the corresponding acknowledgment does not depend on the load connected to the decoder (such loads are neither necessary nor hindering).

**Please note...**

**Electrical loads in the loco** that are not connected to the decoder may potentially present a problem (since the decoder cannot turn the load off), because of the 150mA power limit of the MXDECUP. The update process may fail in such cases and the relevant loads must first be removed or remove the decoder from the locomotive.

Make sure the choke coil recommended in chapter 17 is actually installed, if **external buffer circuits** (capacitors) are used to maintain power to the decoder on dirty track sections. Acknowledgments from the decoder to the MXDECUP are otherwise not possible.

Although there is a "blind update option" available in ZST that operates without acknowledgements, its use is not really recommended.

First, plug-in the **power supply** at the MXDECUP. The green LED, visible in the connector recess, should now be lit. Next, connect the MXDECUP with the **computer** using either the RS-232 cable or the RS-232 cable with USB converter. The green LED now turns off again (both LED's are dark).

The actual update process is started and controlled with the **"ZIMO Service Tool" (ZST)**, always use the latest version. For English applications use the **ZST extension**, see explanation on previous page):

We can't offer a detailed description here regarding the update process; since ZST will often be modified and expanded (this software performs a number of other tasks within the ZIMO system). In any case, there is a button on the original ZST main page named: "start with MXDECUP online". English speaking users should start the ZST extension, which opens the COM PORT selection page. All further steps, such as selecting the right COM port, the update software file (one file contains all current software versions for all ZIMO decoders), starting, control and terminating the update process are self-explanatory on screen or can be obtained from the help file.

The two LED's at the MXDECUP are flickering very rapidly during the update process (red and green). This indicates that data packets are sent to and acknowledgments received from the decoder. The LED's remain dark once the update process is finished.

If for any reason the update is unsuccessful (indicated by ZST), another update can be started after a waiting period of 5 seconds!

